



2016 New Products



Refrigerants

Page 2



R134a-12oz
Part # 695



R134a-30lb
Part # 690



R1234yf-10lb
Part # 697



R1234yf-25lb
Part # 698

All Refrigerants available for sale in case, single cylinder or truck load quantities

FJC Oil Charge with Extreme Cold Additive

Page 10



PAG 46 with Extreme Cold
Part # 9242
3 oz



PAG 100 with Extreme Cold
Part # 9243
3 oz



PAG 150 with Extreme Cold
Part # 9244
3 oz



Universal PAG with Extreme Cold
Part # 9245
3 oz



Estercool PAG with Extreme Cold
Part # 9247
3 oz

Page 6-8

FJC Oil with Extreme Cold Additive



Estercool with Extreme Cold
Part # 2410
8 oz



Universal PAG with Extreme Cold
Part # 2470
8 oz



PAG 46 with Extreme Cold
Part # 2507
8 oz



PAG 100 with Extreme Cold
Part # 2509
8 oz



PAG 150 with Extreme Cold
Part # 2511
8 oz

Page 8



R1234YF Oil

- For use with R1234YF Refrigerant

Part # 2458
8 oz

Page 21



R1234YF Fittings

- 1/4" SAE x 1/2" ACME Female LH Thread
- connects yellow manifold supply hose to R1234YF refrigerant tank

Part # 6828

Page 21



R1234YF Fittings

- 1/4" SAE x 1/2" ACME Female LH Thread
- connects 1234YF yellow hose to R134a vacuum pump

Part # 6829

FJC Refrigerants



Available for sale as:

- Single case or cylinder
- Pallets
- Truckload



R134a-12 oz

Part # 695

12 oz cans / 12 per case

R134a-30 lb. cylinder

Part # 690

30 lb. cylinder ea.



Next Generation of
Mobile Refrigerant

- Do not mix with R134a
- Requires R1234YF
lubricant



R1234YF

Part # 697

R1234YF 10 lb. cylinder



R1234YF

Part # 698

R1234YF

25 lb. cylinder

**Contact Your FJC Rep
for Deals & Truck
Load Pricing!**



R134 Refrigerant Products



Introducing... FJC Polar Ice® R134a Refrigerant Plus

Part # 501

22 oz. can

- All in One, Design and Components, Designed for Larger Refrigerant Capacity Vehicles such as SUV and Light Trucks
- Simplifies R134a A/C System Recharging.



- Contains 21 oz. R134a PLUS, 1 oz Extreme Cold® additive.
- Easy Fill Dispensing Hose with Pressure Gauge.
- Easy Step by Step Instructions with Filling Chart for Reference.

Part # 525

19 oz. can

- All in One, Design and Components, Simplifies R134a A/C System Recharging.
- Part #525 - Contains 18 oz. R134a PLUS, 1 oz. Extreme Cold®.



- Part #528 – Contains 16 oz. R134a PLUS and 3 oz. Extreme Cold® additive.
- Easy Fill Dispensing Hose with Pressure Gauge. (Included with # 525)
- Easy Step by Step Instructions with Filling Chart for Reference.

Part # 528

19 oz. can refill



Part # 536

14 oz. can refill

- All in One, Design and Components, Simplifies R134a A/C System Recharging.
- Part # 533 Contains 13 oz. R134a PLUS and 1 oz. Extreme Cold® Additive.
- Part # 536 Contains 12 oz. R134a PLUS, 2 oz. Extreme Cold® Additive, Leak Sealer and Conditioners.
- Packaged for Smaller Capacity A/C Systems.
- Easy fill Trigger Valve with Hose. (Included with # 533)
- Easy Step by Step Instructions With Filling Chart for Reference.

Part # 533

14 oz. can



R134 Refrigerant Products



R134a U-Charge Hose with Gauge

Part # 6036

- For use in adding R134a refrigerant or additives to vehicle
- Lowside Gauge monitors pressure to aid in getting a correct charge

R134a U-Charge Hose

Part # 6035

- Reusable charging hose for adding R134a refrigerant and oil charge to R134a systems under pressure.
- For use with: FJC Part #'s 4921, 9140, 9145, 9147 and 9150.

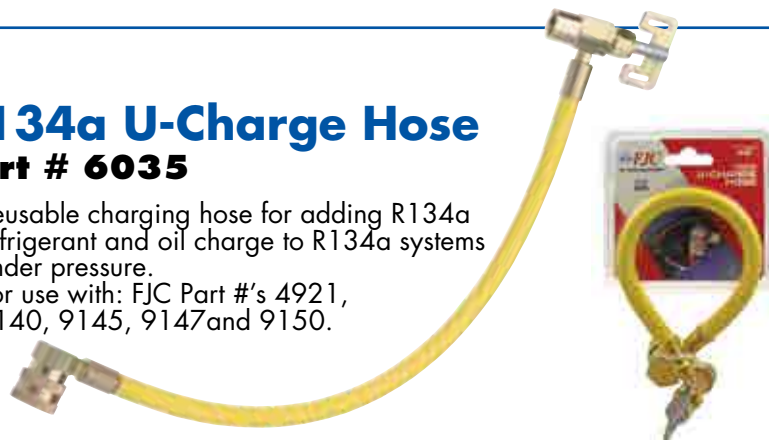

R134a Premium Refrigerant with Leak Stop & New Visual Red Dye

Part # 618

- Contains 12 oz R134a with Leak Stop with NEW VISUAL RED DYE and Oring conditioners.
- NO UV LEAK DETECTION LIGHT NEEDED.



FJC Polar Ice® R134a Recharge Kit

Part # 582

- 36 oz of R134a with Synthetic Booster Additives
- Deluxe U-Charge Hose with Gauge Included
- Instructions Included



R134a Refrigerant with Extreme Cold® Synthetic Booster

Part # 685

- Contains 12 oz R134a with Extreme Cold® Synthetic Booster.
- Lowers Duct Temperatures up to 15% - Compatible with all Ester and PAG oils.
- Extends Compressor Life - Restores Seals and Orings.



R134a Refrigerant with UV Dye

Part # 623

- Contains 12 oz R134a with UV Leak Detection Dye.
- Pin point leaks for quicker repair or add to system to identify future leaks if they occur.
- Compatible with all Ester and PAG oils.



R134a Refrigerant for High Mileage Vehicles

Part # 675

- Contains 12 oz R134a with Leak Sealer and Booster/ Anti Wear Additive.
- Unique formula designed for today's older vehicles.
- Extends the life of older R134a systems.
- Compatible with all Ester and PAG oils.



Kwik Seal Stop Leak

Convenient Aerosol Can with Charging Hose

ADVANCED FORMULA
STOPS LEAKS WHERE OTHERS FAIL

Kwik Seal
Air Conditioning
STOP LEAK
& CONDITIONERS



Part # 9165

- Designed for the do-it-yourself markets, as well as the professional technician.
- Seals most leaks in all metal and rubber components.
- Kwik Seal Stop Leak creates a permanent seal.
- For use in R134a systems only.
- Includes an easy to use hose with R134a quick coupler - no other tools required.
- Kwik seal stop leak will not damage a/c recovery / recycle equipment.
- Add Kwik Seal Stop Leak to any R134a automotive system to prevent leaks.
- Not for use in hybrid vehicles.



Part # 9164

- Contains 2 ounces R134a & 1 ounces of Kwik Seal Stop Leak.
- Not for use in hybrid vehicles.

Kwik Seal STOP LEAK w/Conditioners

Part # 9160 (2 oz)

Part # 9162 (8 oz)

- Seals Most Leaks in All Metal and Rubber Components.
- Creates a Permanent Seal.
- For Use in R134a and R12 Systems.
- Not for use in hybrid vehicles.



R134a/R12 2 oz Handturn Oil and Dye Injector

Part # 2732

- 2 oz. refillable R12/R134a cylinder for adding oil, dye and STOP LEAK.
- Add oil, dye and STOP LEAK to system without adding refrigerant.
- Includes Conversion-Quick Coupler for Servicing R134a Vehicles.



**Kwik Seal
Stop Leak**



Refrigerant Oil

OE Viscosity PAG Oil 46-100-150



PAG 46
Part # 2484 (8 oz)
Part # 2485 (Quart)
Part # 2486 (Gallon)
Part # 2484-55 (55 Gal.)

PAG 100
Part # 2487 (8 oz)
Part # 2488 (Quart)
Part # 2489 (Gallon)
Part # 2487-55 (55 Gal.)

PAG 150
Part # 2490 (8 oz)
Part # 2491 (Quart)
Part # 2492 (Gallon)
Part # 2490-55 (55 Gal.)

Synthetic PAG Oil for Mobile A/C Systems

- As Recommended by OE and Compressor Manufacturers.



OE Viscosity PAG Oil 46-100-150 with Extreme Cold Additive



PAG 46 with Extreme Cold
Part # 2507
 8 oz



PAG 100 with Extreme Cold
Part # 2509
 8 oz



PAG 150 with Extreme Cold
Part # 2511
 8 oz

OE Viscosity PAG Oil 46-100-150 with Fluorescent Leak Detection Dye



PAG 46
Part # 2493 (8 oz)
Part # 2494 (Quart)
Part # 2501 (Gallon)
Part # 2493-55 (55 Gal.)

PAG 100
Part # 2495 (8 oz)
Part # 2496 (Quart)
Part # 2502 (Gallon)
Part # 2495-55 (55 Gal.)

PAG 150
Part # 2498 (8 oz)
Part # 2499 (Quart)
Part # 2503 (Gallon)
Part # 2498-55 (55 Gal.)

- Saves Time over Existing Methods of Dye Injection.
- Can be Detected Using any UV Light.

ATTENTION

A partial charge of FJC PAG Oil with Dye will not provide enough dye for proper fluorescing. **Only** a full system charge during normal service will provide maximum fluorescing for the mobile A/C system.

A partial charge may be added to a system which already contains Fluorescent Dye.



Refrigerant Oil



FJC Universal PAG Oil

- Part # 2470** (8 oz) with Extreme Cold
- Part # 2468** (8 oz)
- Part # 2472** (Quart)
- Part # 2475** (Gallon)
- Part # 2468-55** (55 Gal.)

- Technologically advanced formula, designed to allow one PAG for use in all mobile A/C systems.
- Can be used in R134a and R12 mobile A/C systems.
- Compatible with Mineral, Ester, Paraffin, and other PAG oils.
- Non-Corrosive



FJC Universal PAG Oil with Fluorescent Leak Detection Dye

- Part # 2479** (8 oz)
- Part # 2480** (Quart)
- Part # 2481** (Gallon)
- Part # 2479-55** (55 Gal.)

ATTENTION

A partial charge of FJC PAG Oil with Dye will not provide enough dye for proper fluorescing. **Only** a full system charge during normal service will provide maximum fluorescing for the mobile A/C system.

A partial charge may be added to a system which already contains Fluorescent Dye.

- Compatible with R134a & R12.
- Compatible with Mineral, Ester, Paraffin, and PAG Oil.
- Can be detected using a standard UV light.
- Saves time over existing methods of dye injection.



Refrigerant Oil



Refrigerant Oil

FJC Estercool™ Oil

- Part # 2410** (8 oz) with Extreme Cold
- Part # 2408** (8 oz)
- Part # 2432** (Quart)
- Part # 2439** (Gallon)
- Part # 2455** (55 Gal.)



- The most technologically advanced R134a and R12 oil on the market today.
- Compatible with Mineral, Ester, Paraffin, and PAG Oil.
- One oil for all applications.
- Can be added to any existing R12 or R134a mobile A/C system with Mineral, PAG, Paraffin, or Ester Oil.
- Use to replace PAG, Mineral, or Paraffin Oil.
- An all natural Ester oil, that contains additives which give it the ability to lubricate and protect the system at the same time.
- Prevents acid from forming and inhibits corrosion.

#1 **Choice**



FJC DyEstercool™ Oil

- Part # 2443** (8 oz)
- Part # 2445** (Quart)
- Part # 2447** (Gallon)
- Part # 2449** (55 Gal.)



Contains FJC Universal Fluorescent Leak Detection Dye

- Compatible with R134a & R12.
- Compatible with Mineral, Ester, Paraffin, and PAG Oil.
- Can be detected using any standard UV light.
- Saves time over existing methods of dye injection.

ATTENTION

A partial charge of DyEstercool™ Oil will not provide enough dye for proper fluorescing. **Only** a full system charge during normal service will provide maximum fluorescing for the mobile A/C system.

A partial charge may be added to a system which already contains Fluorescent Dye.

FJC R1234YF Oil

- Part # 2458** (8 oz)
- For use with R1234YF Refrigerant



FJC Hybrid Vehicle A/C Oil

- Part # 2450** (8 oz)
- For use in A/C systems in Hybrid vehicles.
- Consult manufacturer's specifications for vehicle specs and oil capacity.



FJC Mineral Oil

- Part # 2205** (Quart)
- For use in R12 Automotive A/C systems.
- 525 Viscosity



FJC Vacuum Pump Oil

- Part # 2202** (8 oz)
- Part # 2200** (Quart)
- Part # 2200-55** (55 Gal.)

- Meets specifications for all Rotary Vane Vacuum Pumps.



Oil Injector



R12 A/C Oil Injector

Part # 2729

(R12 Injector)

- Use injector to add 2 oz. of oil to an R12 air conditioning system under pressure or during service.

Part # 2726 (Replacement Hose R12 Injector)

Part # 2736 (Replacement Oring)



R134a A/C Oil Injector

Part # 2734

(R134a Injector)

- Use injector to add 2 oz. of oil to an R134a air conditioning system under pressure or during service.

Part # 2727 (Replacement Hose R134a Injector)

Part # 2736 (Replacement Oring)



Syringe Oil Injector

Part # 2731

- 6 inch extension hose.
- 2 ounce plastic plunge oil injector.
- Inject oil into system during service (non-pressurized - open system).
- Easily inject correct amount of oil into compressor, evaporator, accumulator, drier, or condenser.

Note: This injector is not designed to inject oil into a system under pressure.



R134a Flow Through Oil Injector

Part # 2738

- 2 oz refillable R134a oil injector.
- Connects between charging hose and vehicle service port to add oil.
- Add oil while system is under pressure or vacuum.

Part # 2736 (Replacement Oring)

Part # 2602 (Replacement Male Service End)



R134a/R12 Injector - 2 oz Handturn Oil and Dye Injector

Part # 2732

- 2 oz refillable R134a/R12 oil and UV dye injector.
- Add oil or UV dye to system without adding refrigerant.

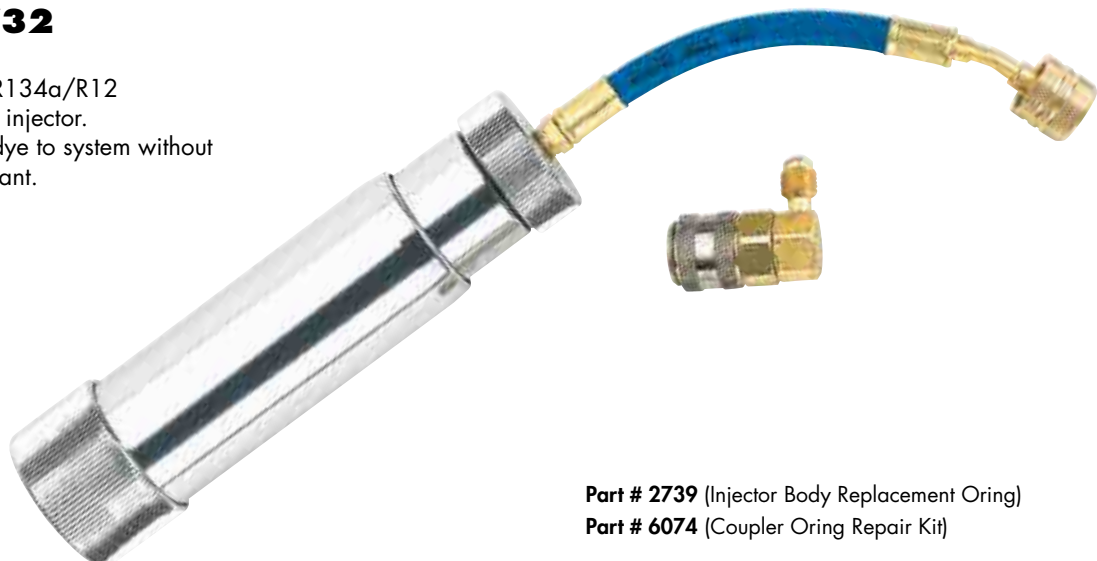

Part # 2739 (Injector Body Replacement Oring)

Part # 6074 (Coupler Oring Repair Kit)



R134a Oil Charge



FJC PAG 46 R134a Oil Charge

Part # 9142

- 1 oz R134a
- 2 oz PAG 46



FJC PAG 100 R134a Oil Charge

Part # 9143

- 1 oz R134a
- 2 oz PAG 100



FJC PAG 150 R134a Oil Charge

Part # 9144

- 1 oz R134a
- 2 oz PAG 150



FJC Universal PAG R134a Oil Charge

Part # 9145

- 1 oz R134a
- 2 oz FJC Universal PAG Oil

FJC Oil Charge with Extreme Cold Additive



PAG 46 with Extreme Cold

Part # 9242

3 oz



PAG 100 with Extreme Cold

Part # 9243

3 oz



PAG 150 with Extreme Cold

Part # 9244

3 oz



Universal PAG with Extreme Cold

Part # 9245

3 oz



Estercool PAG with Extreme Cold

Part # 9247

3 oz

R134a Refrigerant for High Mileage Vehicles

Part # 677

- Contains 1 oz R134a, 2 oz Leak Sealer and Booster/Anti Wear Additive.
- Unique formula designed for today's older vehicles.
- Extends the life of older R134a systems.
- Compatible with all Ester and PAG oils.



R134a DyeCharge

Part # 4921

- Fluorescent Dye for R134a A/C systems.
- R134a pressurized - single use can.
- Use Part #4960 Dye Injector to install.



FJC Estercool™ R134a Oil Charge

Part # 9147

- 1 oz R134a
- 2 oz FJC Estercool™ Oil



Hybrid Oil Charge

Part # 9148

- 1 oz R134a
- 2 oz Hybrid vehicle A/C lubricant



R134a Oil Charge



R134a Stop Leak w/Red Dye

Part # 9140

- Seals Leaks in Orings & Gaskets. R134a Refrigerant.
- Sealers with Oring Conditioners.
- Red Leak Detection Dye.
- No UV Light Necessary to View the Dye.
- Will not harm vehicle A/C system or Refrigerant Recovery or Charging Equipment.



Compressor Quiet

Part # 9159 (2 oz)

Compressor Oil Additive designed to help Silence Noisy Compressors.

- Improves Compressor Operation.
- Helps Lower Compressor Operating Temperatures.



R134a U-Charge Hose

Part # 6035

- Reusable charging hose for adding R134a refrigerant and oil charge to R134a systems under pressure.
- For use with: FJC Part #'s 4921, 9140, 9145, 9147 and 9150.

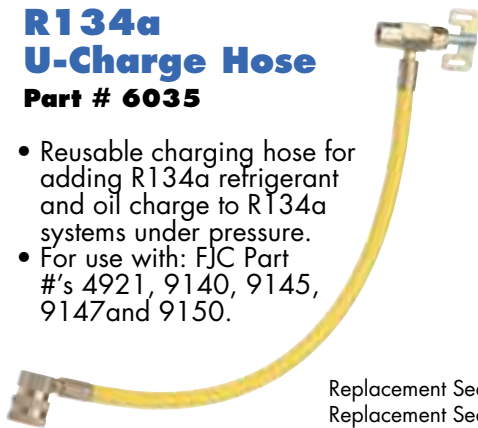

Replacement Seal - #6041
Replacement Seal - #4008

R134a U-Charge Hose with Gauge

Part # 6036

- For use in adding R134a refrigerant or additives to vehicle
- Lowside Gauge monitors pressure to aid in getting a correct charge



Part # 9150

- Install in R134a Systems Only.
- 2 oz R134a + 1 oz Extreme Cold®.

EXTREME COLD®

High Performance Refrigerant Additive
Lowers Duct Temperature Up to 15%



Part # 9153(2 oz)

- Install in Any Mobile A/C Refrigerant System.
- Single Application



Part # 9158(8 oz)

- 2 oz per Application
- Install in Any Mobile A/C Refrigerant System.

Extreme Cold®
Additive

A/C Flush



Extreme Klean A/C Flush

Part # 2400 (Quart)
Part # 2401 (Gallon)

- EVAPORATES - NO RESIDUE
- Removes oil and contaminants within the A/C system.
- Compatible with all Mobile A/C Refrigerants and Oils.
- Use with Part #2710 Flush Kit.
- For Shipping, refer to MSDS.



Kwik Klean A/C Flush

Part # 2405 (Quart)
Part # 2406 (Gallon)
Part # 2407 (Aerosol - 17 oz.)
Part # 2405-55 (55 Gal.)



- Removes oil and contaminants that can block the flow of oil and refrigerants.
- For use with R12, R134a and Blends.
- Compatible with all refrigerant oils.
- Use FJC #2710 Flush Kit with Qt. #2405/Gal. #2406.
- Part #2407, 17 oz. Aerosol, includes flush tube.



FJC A/C Flush Solvent

Part # 2032 (Quart)
Part # 2128 (Gallon)



- Developed specifically for use in air conditioning systems using refrigerants R12, R134a, and Blends.
- Compatible with Mineral, Ester, Paraffin, and PAG oil.
- Removes moisture, acid, and contaminants that can block the flow of oil and refrigerants, resulting in system failure.
- Use with FJC Flush Kit - Part #2710.

Air Conditioning Equipment Flush

Part # 2130

- Designed to remove harmful leak stop agents or contaminants that can damage recovery/reclaim equipment.



Foaming Condenser Cleaner

Part # 5915



- Powerful foaming action penetrates deep within condenser fins for superior cleaning.
- Cleans outside of condenser to enhance airflow for maximum cooling.
- Safe for use on all plastics and metals.
- Contains 18 ounces.

Foaming Evaporator Cleaner

Part # 5914



- Cleans outside surface of evaporator.
- Foaming, cleaning action designed to fill evaporator case to ensure complete surface cleaning.
- Restores fresh neutral scent to vehicle's interior.
- Contains 18 ounces.

Evaporator Odor Control

Part # 5909



- Instantly eliminates odors caused by fungus and bacteria in the evaporator or ductwork.
- Helps prevent the reoccurrence of odors for up to a year.
- 9 ounces easy to use aerosol spray.
- Fresh lemon scent.
- Follow simple directions on can.

A/C Flush Accessories



FJC Flush Kit

Part # 2710

- Reusable canister, holds up to 18oz.
- Designed specifically for use with all FJC A/C Flushes.
- Use Flush Kit to remove contaminants, moisture, and acid from air conditioning systems using refrigerants R12, R134a, or R22.
- Detailed instructions are included.
- **Quick disconnect air fitting not included.**



Kit Contains: Canister, Hose, Nozzle, Air Cut Off Valve and Instructions.

Replacement Parts:

Part # 2716 - Replacement Hose for Flush Kit

Part # 2717 - Replacement Oring

Part # 2718 - Air Cut Off Valve

Flush Nozzle

Part # 2712

- Designed specifically for use with FJC A/C FLUSH SOLVENT or equivalent.
- Note:** Old style flush nozzles WILL NOT provide adequate flow using FJC A/C FLUSH SOLVENT.
- Part # 2714** - Replacement Tip for Flush Nozzle.



Flushing Assortment

Part # 2768

Contains:

- 1 - **Part # 2710** - Flush Kit
- 1 - **Part # 2770** - Flush Coupler
- 1 - **Part # 2783** - Goggles



Flush In A Bucket Assortment

Part # 1996

- Contains everything necessary to flush a mobile A/C system.

Assortment Includes:

- 1 - **Part # 2406** - Flush
- 1 - **Part # 2710** - Flush Kit
- 1 - **Part # 2770** - Flush Coupler
- 1 - **Part # 2815** - Manual
- 1 - **Part # 2783** - Goggles
- 1 - Bucket



Measuring Cup

Part # 2782

- Measure the exact amount of oil for the system being serviced.
- Helps eliminate the chance of system failure due to incorrect oil charge.
- Made of durable plastic with a 20 ounce scale.



Flush Coupler

Part # 2770

- Use the Flush Coupler to capture flush as it leaves the component being cleaned.
- Connects to outlet of the component being flushed.
- Helps keep the vehicle and shop clean during the flushing process.



Note: Will not connect to block type fittings.

Replacement Collars - Part #'s 2775, 2776, 2777, 2778, 2779

Block Fitting Adapters

Kit to Adapt Flush Coupler to Chrysler Block Type Fittings

Part # 2774

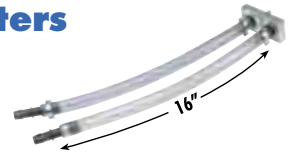

Safety Goggles

Part # 2783

- Safety splash goggles.
- Protects eyes during system service.



HD Flush In A Bucket Assortment

Part # 1996HD

- Contains everything necessary to flush a mobile A/C system.

Assortment Includes:

- 1 - **Part # 2406** - Flush
- 1 - **Part # 2710** - Flush Kit
- 1 - **Part # 2770** - Flush Coupler
- 1 - **Part # 2783** - Goggles
- 1 - Bucket



A/C Flush Accessories



Fluorescent Leak Detection Dyes

Air Conditioning Leak Detection Dye

- All FJC Dyes can be detected using any UV or Blue Light.
- "POE" Ester based.
- Safe for Hybrids.



Part # 4903



Part # 4910



Part # 4914



Part # 4916



Part # 4917



Part # 4918



Part # 4921



Part # 4933



Part # 4934

Part #	Description	Recommended Usage	Size	Std. Pack
4903	Universal A/C Fluorescent Leak Detection Dye	10 Applications per cartridge	1 Cartridge (4903)	1
4910	Universal A/C Fluorescent Leak Detection Dye R12 & R134a Systems	1/4 oz per 12 oz oil	1 oz (4910)	6
4914	1/4 oz single application Universal A/C Fluorescent Dye R12 and R134a	1/4 oz per 12 oz oil	1/4 oz (4914)	12
4916 4917 4918	Universal A/C Fluorescent Leak Detection Dye R12 & R134a Systems	1/4 oz per 12 oz oil	4 oz (4916) 8 oz (4917) 16 oz (4918)	4 4 1
4921	DyeCharge™ Fluorescent Dye For R134a A/C Systems R134a pressurized - Single use can Use Part # 4960 Injector to install	1 can per automotive system	3 oz (4921)	12
4933 4934	R134a/R12 Visual RED DYE For all automotive AC systems	1 oz per 12 oz oil	1 oz (4933) 8 oz (4934)	6 4

Fuel-Motor Oil - Transmission - Power Steering Dye



Part # 4923



Part # 4924

Part #	Description	Recommended Usage	Size	Std. Pack
4923 4924	Gasoline or Diesel Engine oil Transmission oil Power Steering Gasoline & Diesel Fuel Hydraulic Fluid	1 oz to 5 quarts 1 oz to 8 pints 1 oz per application 1 oz to 5 gallons 1 oz to 1 gallon	1 oz (4923) 8 oz (4924)	6 4

Radiator Coolant Dye



Part # 4926



Part # 4927



Part # 4928



Part # 4929

Part #	Description	Fluorescent Color	Recommended Usage	Size	Std. Pack
4926	Universal Radiator Coolant Dye (Will not change the color of any coolant)	Blue	1 oz to 4 gallons	1 oz (4926)	6
4927	Extended Life Radiator Coolant Dye (Only use with orange and pink coolants. Will not change the color of coolant)	Green	1 oz to 6 gallons	1 oz (4927)	6
4928	Radiator Coolant Dye	Green	1 oz to 4 gallons	1 oz (4928)	6
4929	Radiator Coolant Dye	Green	1 oz to 4 gallons	8 oz (4929)	4

Caution: DO NOT use any of the above Dyes in Brake Fluid Systems.

Leak Detection Accessories



Electronic Leak Detector

Part # 5110



- Detects all CFC, HFC, HCFC and new HFO Refrigerants
- Automatic calibration
- Mechanical pump design
- 3 Sensitivity levels
- Low battery indicator
- Operates on 4 AA batteries
- Made in USA
- Compliant with SAE J2791
- Return and repair warranty

Deluxe Electronic Leak Detector

Part # 5120

- Detects all CFC, HFC, HCFC and new HFO Refrigerants
- Heated sensor technology
- Automatic calibration
- 3 Sensitivity levels
- Digital leak size alarm & indicator
- Operates on 4 AA batteries
- Made in USA
- Compliant with SAE J2791
- Hard blow molded case included
- Return and repair warranty



Leak Detector Accessories

Part #	Description
5121	Replacement Sensor with Filter
5122	Replacement Sensor Filters (5 Pack)
5123	Refrigerant Leak Test Reference Vial

Part #	Description
5124	Refrigerant Parts Kit (includes Sensor, Test Vial & Filter Kit)
5125	Carrying Case 14"

Fluorescent Dye Kit

Part # 4971

- Kit contains everything necessary to perform leak detection on all A/C systems, engine oil, fuel systems, transmissions and coolant system.



Kit Contains:

Qty	Part #	Description
1	2730	R12 & R134a Hand Turn Dye Injector
12	4914	1/4 oz Universal A/C Dye
12	4915	Dye Installed Labels
3	4923	1oz Motor Oil, Fuel, Transmission Dye
3	4928	1oz Coolant Dye
1	4958	UV Safety Goggles
1	4966	LED Blue Light
1		Carrying Case

Slim Design LED Blue Light for UV Leak Detection

Part # 4967

- Compact - High Intensity - UV Inspection light
- Operates on 3 - AA batteries



Adjustable Focus, LED Blue Light with Strobe Effect

Part # 4966

- Super bright LED with Adjusting focus point
- ON/OFF strobe effect - easier to pin point leaks
- Operates on 3 - AAA Batteries



UV Dye Kit

Part # 4972

Kit Contains:

Qty	Part #	Description
1	4967	UV Light
1	2730	Injector
1	4910	A/C Dye 1 oz
1	4923	1oz Motor Oil
1	4928	1oz Coolant Dye
1	4958	UV Safety Goggles



UV Dye Kit

Part # 4975

Kit Contains:

Qty	Part #	Description
1	4966	UV Light
1	4958	UV Safety Goggles
1	4901	Injector w/Dye
3	4923	1oz Motor Oil
3	4928	1oz Coolant Dye
25	4915	Dye Installed Labels
1		Carrying Case



HD Fluorescent Dye Kit

Part # 4982

- Kit contains everything necessary to perform leak detection on all A/C systems, engine oil, fuel systems, transmissions and coolant system.



Kit Contains:

Qty	Part #	Description
1	2730	R12 & R134a Hand Turn Dye Injector
12	4914	1/4 oz Universal A/C Dye
12	4915	Dye Installed Labels
1	4924	8oz Motor Oil, Fuel, Transmission Dye
1	4929	8oz Coolant Dye
1	4958	UV Safety Goggles
1	4966	LED Blue Light
1		Carrying Case

HD Fluorescent Dye Kit

Part # 4983

Kit Contains:

Qty	Part #	Description
1	4966	UV Light
1	4958	UV Safety Goggles
1	4901	Injector w/Dye
1	4924	8oz Motor Oil
1	4929	8oz Coolant Dye
10	4915	Dye Installed Labels
1		Carrying Case



Leak Detection Accessories



Leak Detection Accessories

Fluorescent Leak Detection Light

12V Leak Detection UV/Blue Light

Part # 4965

- High intensity 12 volt UV lamp.
- Instant on and off.
- Long cord for easy access.
- Detects all dyes.
- UV Safety Glasses included.



Part # 4947 - Replacement Bulb

Part # 4949 - Replacement Lenses

R134a DyeCharge™

Part # 4921

- Fluorescent Dye R134a for A/C systems.
- R134a pressurized - single use can.
- Use **Part # 4960** Dye Injector to install.



A/C UV Dye Cartridge Injector Kit

Part # 4901

- 10 shot application dye cartridge adds the precise amount of dye through the low side service port.
- Kit includes UV dye injector, 10 shot cartridge, injector hose and R134 service coupler.
- Requires replacement UV dye cartridge FJC Part #4903



FJC Hand Turn Dye Injector

Part # 2730



- Inject 1/4 to 1/2 ounce of Fluorescent Dye into a R12 or R134a A/C System under pressure.
- Refillable

Part # 2737 (Injector Replacement Oring)

Part # 6074 (Coupler Oring Repair Kit)

Rechargeable LED UV Leak Detection Light

Part # 4963

- Fluoresces all UV Dye.
- Provides Hours of Use on a Single Charge.
- Detects all Dyes.
- Charger Included.



Dye Injector For FJC DyeCharge™

Part # 4960

- Easy and Quick method of injecting FJC DyeCharge™ into a pressurized R134a A/C system.
- Anti-Blowback design
- For use with **Part # 4921**

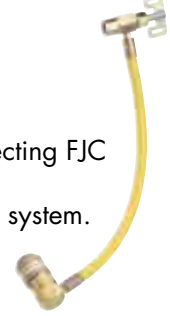

Replacement A/C UV Dye Cartridge

Part # 4903

- Replacement A/C UV dye cartridge for FJC #4901 dye injector kit. 10 applications per cartridge



A/C Dye Injectors

Part # 2733

(R134a Dye Injector)

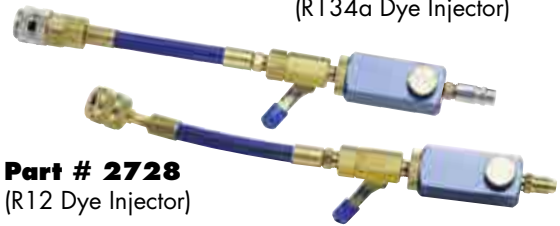

Part # 2728

(R12 Dye Injector)

- Refillable
- Inject 1/4 ounce of Fluorescent Dye into an A/C system under pressure or during service.

Part # 2735 Replacement Oring

Fluorescent "Dye Installed" Decals

Part # 4915-100

- Place on vehicle when installing Fluorescent A/C Dye.



UV Safety Glasses

Part # 4958

- Enhances Dye, making Leak Detection easier.
- Blocks harmful UV rays.



FJC DyeFree™ Fluorescent Dye Cleaner

Part # 4946

- Removes fluorescent leak detection dye from areas where leaks are found and repaired.
- Convenient 32 ounce spray bottle.



Leak Detection Accessories

Manifold Gauge Sets with Case



Heavy Duty R134a Aluminum Manifold with 10ft Charging Hoses

Part # 6799

- Extra Large 80mm Dials
- 10 ft Red & Blue Hose & 8 ft Yellow Hose
- Manual Couplers



Part # 6134 Diaphragm Repair Kit
Part # 6138 Replacement Lenses
Part # 6140 Replacement Handle & Stem Kit

R134a/R12 Dual Aluminum Manifold Gauge Set

Part # 6698

- R134a/R12 Dual Manifold with 72" Charging Hoses
- 72" Charging Hoses & R134a Tank Adapter
- Manual Couplers



Part # 6134 Diaphragm Repair Kit
Part # 6139 Replacement Lenses
Part # 6140 Replacement Handle & Stem Kit

R1234YF Aluminum Manifold Gauge Set

Part # 6850

- Service R1234YF systems
- 72" Charging Hoses
- Manual Couplers



R134a Aluminum Manifold Gauge Set

Part # 6766P

- R134a Aluminum Manifold
- 72" Charging Hoses
- Manual Couplers

Part # 6134 Diaphragm Repair Kit
Part # 6139 Replacement Lenses
Part # 6140 Replacement Handle & Stem Kit



Professional Series R134a R12 Dual Aluminum Manifold Gauge Set

Part # 6750

- Professional R134a/R12 Dual Manifold Gauge Set
- Low Permeation, 72" Charging Hose Set & R134a Tank Adaptor
- Manual Couplers

Part # 6139 Replacement Lenses
Part # 6140 Replacement Handle & Stem Kit
Part # 6365 Replacement 72" Charging Hose



R134a Aluminum Manifold Gauge Set and Tool Assortment

Part # 6785

- R134a Aluminum Manifold with 72" Charging Hoses
- Manual Couplers
- Includes Valve Core Tool, R134a Can Tap, Bimetal Pocket Thermometer

Part # 6134 Diaphragm Repair Kit
Part # 6139 Replacement Lenses
Part # 6140 Replacement Handle & Stem Kit



R134a Brass Manifold Gauge Set

Part # 6725

- R134a Brass Manifold
- 72" Charging Hoses
- Manual Couplers

Part # 6139 Replacement Lenses
Part # 6141 Replacement Metal Handle Set





R134a Manifold Gauge Sets

R134a Aluminum Block Manifold Gauge Sets

- Aluminum Block Design with Sight Glass.
- Available with different lengths of Hoses & Couplers.
- Professional Quality.
- Anti-Flutter Design Gauges.
- Additional Access Port.
- Attractive Clamshell Packaging.



	Hose Set Length	With Quick Couplers	With Manual Couplers
Standard Hose	36"	6760	6765
Standard Hose	72"	6761	6766
Standard Hose	96"	6763	6768
Premium Hose	36"	6773	
Premium Hose	72"	6775	
Premium Hose	96"	6776	
Part # 6752 Aluminum Manifold Block with Gauges Only No Hoses & No Couplers			



Part # 6134 Diaphragm Repair Kit
Part # 6139 Replacement Lenses
Part # 6140 Replacement Handle & Stem Kit

R134a Brass Manifold Gauge Sets

- Brass Body Design.
- Anti-Flutter Design Gauges.
- Available with different lengths of Hoses & Couplers.
- Professional Quality.
- Attractive Clamshell Packaging.



Standard Hose
Standard Hose
Standard Hose

	Hose Set Length	With Quick Couplers	With Manual Couplers
Standard Hose	36"	6714	6720
Standard Hose	72"	6715	6721
Standard Hose	96"	6717	6722
Part # 6701 Brass Manifold Block with Gauges Only No Hoses & No Couplers			

Part # 6139 Replacement Lenses
Part # 6141 Replacement Metal Handle Set



Aluminum Dual Manifold Gauge Set

Part # 6697

- For use with R134a, R12, and R22.
- Aluminum Block Design.
- Complete with 72" Hose Set.
- R134a Quick Couplers Included.
- Professional Quality.



Part # 6134 Diaphragm Repair Kit
Part # 6139 Replacement Lenses
Part # 6140 Replacement Handle & Stem Kit

Brass Dual Manifold Gauge Set

Part # 6692

- For use with R134a, R12 and R22
- Brass Block Design
- Complete with 72" Hose Set
- R134a Quick Couplers Included
- Professional Quality



Part # 6139 Replacement Lenses
Part # 6141 Replacement Metal Handle Set

R12 Manifold Gauge Sets



R12 Aluminum Block Manifold Gauge Sets

- Aluminum Block Design with Sight Glass.
- Available with different lengths of hoses.
 - Professional Quality.
 - Anti-Flutter Design Gauges.
 - Additional Access Port.

Part # 6134 Diaphragm Repair Kit
 Part # 6139 Replacement Lenses
 Part # 6140 Replacement Handle & Stem Kit

Hose Set Length	Standard Hose
36"	6643
72"	6647
96"	6649

Part # 6641 R12 Aluminum Manifold Block with Gauges Only No Hoses

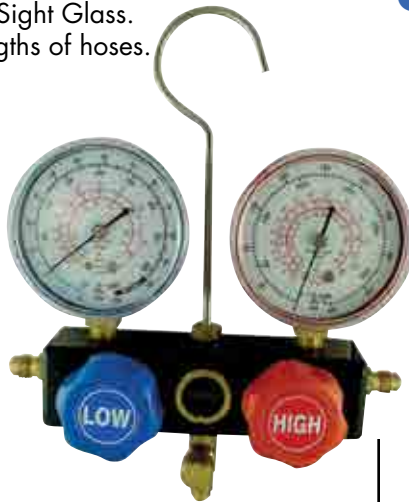

R12 Brass Manifold Gauge Sets

- Brass Body Design.
- Anti-Flutter Design Gauges.
- Available with different lengths of hoses.
- Professional Quality.

Part # 6139 Replacement Lenses
 Part # 6141 Replacement Metal Handle Set

Hose Set Length	Standard Hose
36"	6603
72"	6607
96"	6609

Part # 6601 R12 Brass Manifold Block with Gauges Only No Hoses



Rubber Gauge Protector

- Protects Gauge if Dropped
- Fits 2 1/2" Gauge

Part # 6142 HS
 Part # 6143 LS
 Part # 6144 (Set of 1 each)

Part # 6148 80mm Gauge - HS
 Part # 6149 80mm Gauge - LS
 Part # 6150 80mm Gauge (Set of 1 each)



Note: Gauges not included

R12, R134a, and R1234YF Replacement Gauges

- Service R1234YF, R134a, and R12 systems
- 72" Charging Hoses
- Manual Couplers



Part # 6831
 R1234YF Highside Gauge



Part # 6832
 R1234YF Lowside Gauge

R1234YF



Dual Gauges
 (2.5")



Part # 6127
 R134/R12/R22 Highside Gauge

Part # 6128
 R134/R12/R22 Lowside Gauge



Part # 6135
 R134a Highside Gauge



Part # 6136
 R134a Lowside Gauge

R134a



Part # 6132
 R134a Highside Gauge



Part # 6133
 R134a Lowside Gauge

R134a 80 mm (3.15")



Part # 6095
 R12 Highside Gauge



Part # 6096
 R12 Lowside Gauge

R12 (2.5")



R134a Service Couplers

BMW R134a Manual Coupler

High Side
Part # 6020



- Extended body for hard to reach service ports on some BMW's.

14mm x 1.5 R134a Service Couplers

R134a Manual Coupler

High Side
Part # 6001



- R134a Manual Coupler
- 14mm x 1.5 Hose Connection

Oring Repair Kit
Part # 4211

Low Side
Part # 6002



Oring Repair Kit
Part # 4187

90° R134a Quick Coupler

High Side
Part # 6005



- 14mm x 1.5
- Anti blowback
- Replacement Coupler for all R134a Manifold Gauge Sets.

Coupler Oring Repair Kit
Part # 6073

Low Side
Part # 6006



Coupler Oring Repair Kit
Part # 6074

Straight R134a Quick Coupler

High Side
Part # 6007



- 14mm x 1.5
- Anti blowback
- Replacement Coupler for all R134a Manifold Gauge Sets.

Coupler Oring Repair Kit - Part # 6073

Low Side
Part # 6008



Coupler Oring Repair Kit - Part # 6074

Coupler Sets

(see above for info)



6001 # 6002

Part # 6011

- Set of #6001 and #6002
- R134a Manual Coupler
- 14mm x 1.5 Hose Connection

1/4" R134a Manual Service Couplers

90° R134a Quick Coupler

High Side
Part # 6003



- 1/4 Hose Connection
- Use when converting R12 Gauge Set to R134a

Coupler Oring Repair Kit - Part # 4211

Low Side
Part # 6004



Coupler Oring Repair Kit - Part # 4187



6005 # 6006

Part # 6012

- Set of #6005 and #6006
- 14mm x 1.5
- Anti blowback
- Replacement Coupler for all R134a Manifold Gauge Sets.

1/4" R134a Service Couplers

90° R134a Quick Coupler

High Side
Part # 6009



- 1/4" Hose Connection
- Use when converting R12 Gauge Set to R134a.
- Anti blowback

Coupler Oring Repair Kit
Part # 6073

(For use with R12 Hoses)

Low Side
Part # 6010



Coupler Oring Repair Kit
Part # 6074



6007 # 6008

Part # 6013

- Set of #6007 and #6008
- 14mm x 1.5
- Anti blowback
- Replacement Coupler for all R134a Manifold Gauge Sets.



6003 # 6004

Part # 6026

- Set of #6003 and #6004
- 1/4 Hose Connection
- Use when converting R12 Gauge Set to R134a

R134a Service Couplers

R12 to R134a Conversion Products



Manual Coupler Manifold Gauge Set Conversion Kit



Part # 6021

- Converts R12 Gauges to R134a Gauges.
- Contains Manual R134a Couplers and Adapter for R134a Refrigerant Tank.

*Kit Contains:	
1 ea. Part # 6001	
1 ea. Part # 6002	
1 ea. Part # 6015	
2 ea. Part # 6018	

Coupler Repair Kit - Part # **4211** for Highside Coupler
Coupler Repair Kit - Part # **4218** for Lowside Coupler

Quick Coupler Manifold Gauge Set Conversion Kit



Part # 6025

*Kit Contains:	
1 ea. Part # 6009	
1 ea. Part # 6010	
1 ea. Part # 6015	

- Converts R12 Gauges to R134a Gauges.
 - Contains R134a 90° Quick Couplers and Adapter for R134a Refrigerant Tank.
 - Anti blowback
- Coupler Repair Kit - Part # **6073** for Highside Coupler
Coupler Repair Kit - Part # **6074** for Lowside Coupler

R1234YF Manifold Gauge Set Conversion Kit, Couplers & Fittings

R1234YF Highside Manual Coupler with M12 fitting



Part # 6801

R1234YF Lowside Manual Coupler with M12 fitting



Part # 6802

R1234YF Coupler to 1/4" Hose Adapter

Part # 6826



R1234YF Coupler to R134a Hose Adapter

Part # 6827



R1234YF Fittings

- 1/4" SAE x 1/2" ACME Female LH Thread
- connects yellow manifold supply hose to R1234YF refrigerant tank

Part # 6828

R1234YF Fittings

- 1/4" SAE x 1/2" ACME Female LH Thread
- connects 1234YF yellow hose to R134a vacuum pump

Part # 6829

R1234YF Conversion Kit with Manual Couplers

Part # 6820



R134a Adapters

Vacuum Pump Adapter

- 1/4" Flare Female x 1/2" ACME Male.
- Connects 1/2" ACME R134a Hose to 1/4" Service Port on Vacuum Pump.

Part # 6014



Replacement Seal - Part # 6051

R134a Refrigerant Tank Adapter

- 1/2" ACME Female x 1/4" Male Flare.
- Connects R12 Hose to R134a Refrigerant Tank.

Part # 6015



Replacement Seal - Part # 6052

R134a Coupler to R12 Hose Adapter

- 14mm x 1.5 x 1/4" Male Flare.
- Connects R12 Hose to 14mm x 1.5 R134a Service Coupler.

Part # 6018



Replacement Oring - Part # 4008

R134a Tank Adapter

- Reclaim all Refrigerant from R134a Cylinders.
- Attaches to tank and Lowside Service Coupler.

Part # 6016



R134a Manifold/Hose Adapter Assortment

Part # 6072

- Common Adapter Fittings for hoses on R134a Manifold Gauge Sets



*Kit Contains:	
1 ea. Part # 6014	2 ea. Part # 6018
1 ea. Part # 6015	1 ea. Part # 6019
1 ea. Part # 6016	1 ea. Part # 6038
2 ea. Part # 6017	

R134a Manifold Coupler and Fitting Assortment

Part # 6075

- Replacement R134a Service Couplers, Service Coupler Replacement Orings, Fittings, Thermometer and Nylon Oring Pick





Refrigerant Charging Hoses

R134a Charging Hose

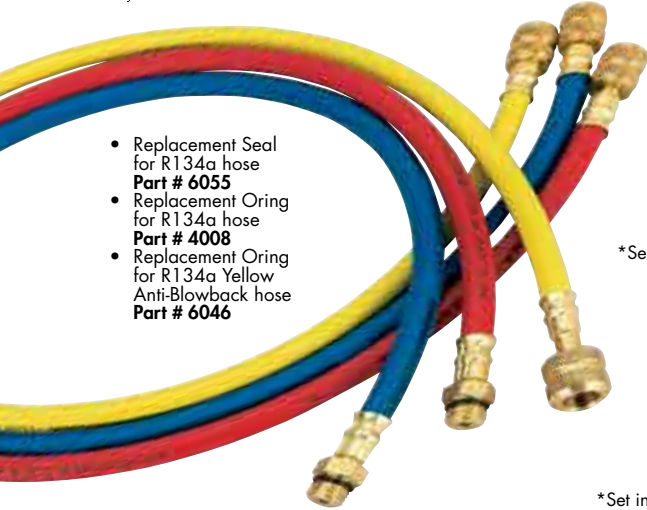

- Replacement Seal for R134a hose
Part # 6055
- Replacement Oring for R134a hose
Part # 4008
- Replacement Oring for R134a Yellow Anti-Blowback hose
Part # 6046

- Premium nylon barrier hose.
- 1/2 ACME x 14mm x 1.5 - Red, Blue
- 1/2 ACME x 1/2 ACME - Yellow hose with anti-blowback

Hose Color	Hose Length			
	36"	72"	96"	120"
Red	6413	6417	6419	6421
Yellow	6423	6427	6429	
Blue	6433	6437	6439	6441
*Set - RYB	6453	6457	6459	

*Set includes one each: Red, Yellow, and Blue Hose

- Standard Hose
- 1/2 ACME x 14mm x 1.5 - Red, Blue
- 1/2 ACME x 1/2 ACME - Yellow w/o anti-blowback

Hose Color	Hose Length		
	36"	72"	96"
Red	6513	6517	6519
Yellow	6523	6527	6529
Blue	6533	6537	6539
*Set - RYB	6553	6557	6559

*Set includes one each: Red, Yellow, and Blue Hose

R134a Hose Connectors



Part # 6017

- Connects red or blue R134a hoses where extra length is needed
- 1/2" ACME male x 14mm x 1.5 female



Part # 6019

- Connects yellow R134a hoses where extra length is needed
- 1/2" ACME male x 1/2" ACME male



Part # 6038

- Prevents refrigerant loss from yellow hose when disconnecting from R134a tank.
- 1/2" ACME Male x 1/2" ACME Female
- #6028 Replacement Oring

Premium R134a Charging Hose Set with Manual Couplers



Part # 6448

- Red and Blue hose set with manual couplers

Premium R134a Charging Hose Set with Quick Couplers



Part # 6447

- Red and Blue hose set with quick couplers

Premium 134a 10 ft R134a Charging Hoses

- Ideal for in field service or replacement on recovery machines.



R134a 72" Red & Blue Charging Hose Set with Manual Couplers

Part # 6450

- Red, Yellow and Blue hose set with manual couplers



R134a 72" Red & Blue Charging Hose Set with Quick Couplers

Part # 6449

- Red, Yellow and Blue hose set with quick couplers



R12 Charging Hose

- Standard Hose
- 1/4" x 1/4" Fittings

Hose Color	Hose Length		
	36"	72"	96"
Red	6313	6317	6319
Yellow	6323	6327	6329
Blue	6333	6337	6339
*Set - RYB	6353	6357	6359
Black		6365	



Hose Color	Hose Length 120"
Red	6421
Blue	6441
Red & Blue	6445

R12 Accessories

Depressors & Seals

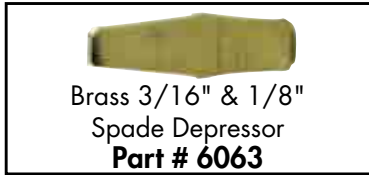

Charging Hose Seal & Depressor Assortment

Part # 6070

- 8 Part Numbers
- 50 Pieces
- Repair parts for most major brands of charging hoses.

R134a Hose Set Seal Repair Kit

Part # 6069



R12 High Side Adapter

Part # 6094

- For GM High Side Service Ports 1991 and up.



Replacement Seal - **Part # 6049**

R12 Adapters with Valve Core

Part # 6091

(90° - 1/4" x 1/4")



Part # 6092

(90° - 1/4" x 3/16")



Part # 6093

90° - 1/4" x 1/8")



Part # 6097

1/4" male x 1/4" male



Neutronics Quick Detect™ A/C Sealant Detection Kit

Part # 2820

- Checks A/C System for harmful sealants.
 - Avoid Damage to Recovery Equipment.
- Contains: 10-Test Cartridges R134a and R12 Couplers, Test Hose, Flow Meter, Instructions.



Sealant Detection Replacement Cartridges

Part # 2821

- Std. Pkg., (5) Cartridges



Heating and A/C Manual

Part # 2819

- Provides general information on A/C theory, system maintenance, trouble shooting & specifications.



R12 Manual Shut Off Valves

Part # 6087 (Red)

12" Hose & Manual Shut Off Valve.

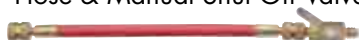

Part # 6089 (Blue)

12" Hose & Manual Shut Off Valve.



Part # 6088 (Yellow)

12" Hose & Manual Shut Off Valve.





Scales

Pro-Charge Deluxe Electronic Scale



Part # 2845

- Digital programmable scales.
- Automatically shuts off refrigerant flow to A/C system when charge is complete.
- 220 lb capacity.
- Uses 5 AA batteries (included)
- Accurate to +/- 1/2 oz. or .5% of total weight, whichever is greater.
- Use with R134a/R12/R22
- Large LCD display.



Note: Remove scale from case as shown above before using.

Pro-Charge Electronic Scale



Part # 2850

Heavy Duty Diecast Aluminum Refrigerant Scale

- ABS Carrying Case.
- 9" x 9" Platform.
- 175 Pound capacity (80 kg).
- Accurate to +/- 1/2 oz. or .5% of total weight, whichever is greater.
- Bubble Key Pad
- 15 Minute Auto Shut Off Feature.
- Extra Large LCD Display lbs/oz./kg
- 9V Battery Included.

Note: Remove scale from case as shown above before using.

Refrigerant-Cylinder Heater Blanket



Part # 2855

- 110 volt AC
- Speeds charging when using 30 lb. and 50 lb cylinders
- 300w element

* Refrigerant tank not included

FJC Air Operated Vacuum Pump

Part # 6900

- 1.3 cfm
- 90 psi minimum air pressure required.



Vacuum Pumps



FJC Combines New Advanced Technology with Dependable Performance...



Part # 6905
1.5 cfm



Part # 6909
3.0 cfm



Part # 6912
5.0 cfm



Part # 6916
7.0 cfm



Part # 6923
3.0 cfm
2 Stage



Part # 6925
5.0 cfm
2 Stage

- ▼ **Two Stage Performance Using Twin-Port Technology.™**
- ▼ **Lightning Fast Design Removes Moisture and Non-Condensable gases that can destroy any A/C or Refrigeration system.**
- ▼ **Lightweight, Durable Construction for Easy Handling and Long-Life Use.**
- ▼ **Tested-Proven-Reliable.**

Part#	Repair Items
6951	1/4" SAE Cap with Strap
6952	1/2" ACME Cap with Strap
6953	"T" Fitting with Caps
6956	Switch - Red
6957	Switch - Black
6958	Exhaust Port (Old Style)
6959	Exhaust Port (New Style)
6960	Capacitor Switch Cover
6961	Fan Blades for models: 6905, 6908, 6909, 6912

Part#	CFM	Micron Rating	Fitting Size	Voltage	Motor	Motor RPM	Oil Cap. Oz	Weight lbs.
6900	1.3		1/4" M.F. x 1/2" ACME	-	-	-	-	2.0
6905	1.5	75	1/4" M.F. x 1/2" ACME	115V, 60 HZ	1/6 HP	1725	6.0	13.9
6909	3.0	75	1/4" M.F. x 1/2" ACME	115V, 60 HZ	1/3 HP	1725	12.0	17.4
6912	5.0	75	1/4" M.F. x 1/2" ACME	115V, 60 HZ	1/3 HP	1725	12.0	22.4
6916	7.0	75	1/4" M.F. x 1/2" ACME	115V, 60 HZ	3/4 HP	1725	17.0	27.7
6923	3.0 2-Stage	50	1/4" M.F. x 1/2" ACME	115V, 60 HZ	1/3 HP	1725	12.0	22.0
6925	5.0 2-Stage	50	1/4" M.F. x 1/2" ACME	115V, 60 HZ	1/2 HP	1725	12.0	25.8

Assortments



Vacuum Pump and R134a Manifold Gauge Set Assortment

Part # 9281

Kit Contains:
1 Part # 6715
1 Part # 6909



Vacuum Pump, R134a Manifold Gauge Set and Installer Assortment

Part # 9282



Kit Contains:

- | | | | |
|---------------|----------------|---------------|---------------|
| 1 Part # 2740 | 1 Part # 2884 | 1 Part # 6016 | 5 Part # 6055 |
| 1 Part # 2744 | 1 Part # 2885 | 2 Part # 6017 | 5 Part # 6061 |
| 1 Part # 2745 | 10 Part # 4008 | 2 Part # 6018 | 1 Part # 6715 |
| 1 Part # 2792 | 1 Part # 4278 | 1 Part # 6019 | 1 Part # 6909 |
| 1 Part # 2882 | 1 Part # 6014 | 1 Part # 6030 | |
| 1 Part # 2883 | 1 Part # 6015 | 1 Part # 6038 | |

Vacuum Pump and R134a Manifold Gauge Set and Electronic Scale Assortment

Part # 9285

Kit Contains:
1 Part # 2740
1 Part # 2792
1 Part # 2850
1 Part # 6030
1 Part # 6715
1 Part # 6909

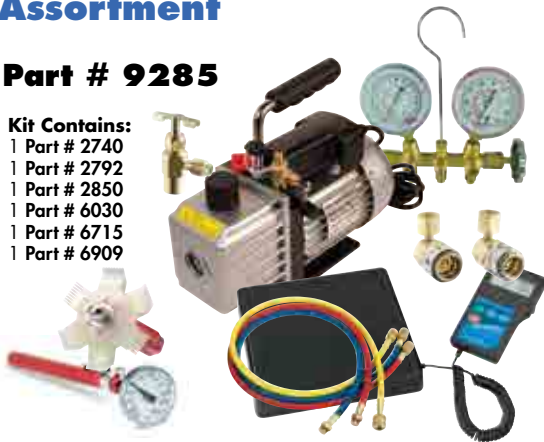

Vacuum Pump, R134a Manifold Gauge Set, Electronic Scale and Installer Assortment

Part # 9287



Kit Contains:

- | | | | |
|---------------|----------------|---------------|---------------|
| 1 Part # 2734 | 1 Part # 2882 | 1 Part # 6014 | 1 Part # 6030 |
| 1 Part # 2740 | 1 Part # 2883 | 1 Part # 6015 | 1 Part # 6038 |
| 1 Part # 2744 | 1 Part # 2884 | 1 Part # 6016 | 5 Part # 6055 |
| 1 Part # 2745 | 1 Part # 2885 | 2 Part # 6017 | 5 Part # 6061 |
| 1 Part # 2792 | 10 Part # 4008 | 2 Part # 6018 | 1 Part # 6715 |
| 1 Part # 2850 | 1 Part # 4278 | 1 Part # 6019 | 1 Part # 6909 |

HD R134a Manifold Gauge Set with 10ft Charging Hoses & 5 cfm Vacuum Pump

Part # 9270

5.0 cfm



HD R134a Manifold Gauge Set with 10ft Charging Hoses & 7 cfm Vacuum Pump

Part # 9271

7.0 cfm



Assortments

FJC Merchandising Displays



3ft Endcap Assortment

Part # 9203



Planogram, hooks and header included.

Assortments do not include endcap or gondola fixtures.

3	Part # 501	2	Part # 2790	1	Part # 6527
3	Part # 525	2	Part # 2792	1	Part # 6537
3	Part # 528	2	Part # 2795	1	Part # 6715
3	Part # 533	1	Part # 4895	3	Part # 9140
3	Part # 536	2	Part # 4897	3	Part # 9142
3	Part # 618	2	Part # 4921	3	Part # 9143
3	Part # 623	2	Part # 5909	3	Part # 9144
3	Part # 675	2	Part # 5914	3	Part # 9145
3	Part # 677	2	Part # 5915	3	Part # 9147
3	Part # 685	2	Part # 6011	3	Part # 9165
2	Part # 2400	2	Part # 6012	2	Part # 4914D
3	Part # 2407	2	Part # 4897	2	Part # 4923D
3	Part # 2408	2	Part # 6025	2	Part # 4927D
3	Part # 2468	2	Part # 6030	2	Part # 4927D
2	Part # 2740	2	Part # 6035	2	Part # 4928D
2	Part # 2744	2	Part # 6036	2	Part # 4933D
2	Part # 2745	2	Part # 6040	2	Part # 9159D
		1	Part # 6517	2	Part # 9160D

4ft Gondola Assortment

Part # 9204



3	Part # 501	3	Part # 2487	4	Part # 5915	4	Part # 9145
3	Part # 525	3	Part # 2490	2	Part # 6011	4	Part # 9147
3	Part # 528	2	Part # 2557	2	Part # 6012	4	Part # 9165
3	Part # 533	2	Part # 2558	2	Part # 6025	2	Part # 4914D
3	Part # 536	2	Part # 2574	2	Part # 6030	2	Part # 4923D
3	Part # 618	2	Part # 2576	2	Part # 6035	2	Part # 4927D
3	Part # 623	2	Part # 2740	4	Part # 6036	2	Part # 4928D
3	Part # 675	2	Part # 2744	2	Part # 6040	2	Part # 4933D
3	Part # 677	2	Part # 2745	1	Part # 6517	2	Part # 9159D
3	Part # 685	2	Part # 2790	1	Part # 6527	2	Part # 9160D
3	Part # 2202	2	Part # 2792	1	Part # 6537		
3	Part # 2400	2	Part # 2795	1	Part # 6715		
3	Part # 2407	1	Part # 4895	1	Part # 6761		
3	Part # 2408	2	Part # 4897	4	Part # 9140		
3	Part # 2450	2	Part # 4921	3	Part # 9142		
3	Part # 2468	4	Part # 5909	3	Part # 9143		
3	Part # 2484	4	Part # 5914	3	Part # 9144		

Refrigerant Products 3 Foot Shelf Display Assortment

Part # 9205



3	Part # 501	3	Part # 618
3	Part # 525	3	Part # 623
3	Part # 528	3	Part # 675
3	Part # 533	3	Part # 685
3	Part # 536	3	Part # 9165

Refrigerant Products 4 Foot Shelf Display Assortment

Part # 9206



3	Part # 501	3	Part # 685
3	Part # 525	3	Part # 9140
3	Part # 528	3	Part # 9142
3	Part # 533	3	Part # 9143
3	Part # 536	3	Part # 9144
3	Part # 618	3	Part # 9145
3	Part # 623	3	Part # 9147
3	Part # 675	3	Part # 9165
3	Part # 677		



A/C Reclaim/Recycle Equipment Replacement Filters

<p>Part # 6990</p>  <p>10" Total Length 3/8" x 3/8" Flare Inlet & Outlet</p>	<p>Part # 6991</p>  <p>9 3/4" Total Length For use with Snap-On Inc. or Sun Recovery machines using a 302V filter. 1/4" x 1/4" Flare Inlet & Outlet</p>	<p>Part # 6992</p>  <p>10" Total Length 1/2" x 1/2" Flare Inlet & Outlet</p>	<p>Part # 6993</p> 
--	---	---	---

<p>Part # 6994</p>  <p>10" Total Length 3/8" x 3/8" Flare Inlet & Outlet</p>	<p>Part # 6998</p> 
--	--

Air Conditioning Equipment Flush

Part # 2130

- Designed to remove harmful leak stop agents or contaminants that can damage recovery/reclaim equipment.



FJC Part #	4 Seasons Part #	Mastercool™ Part #	Robinair Part #	Viper Part #	White Ind. Part #
6990			34430		
6993	59872				16200-SP
6994		62303		315-027-100/6064	
6998			See Below		

One of the Most Popular Refrigerant Recovery Machine Filters in Use Today...

Part # 6998

- This filter is NOT intended for use with Robinair™ A/C Recovery units that require a reset code after filter replacement. See chart shown below for recovery units with this filter.

Fits the Following Robinair™ A/C Recovery Machine Models Shown Below:

17700A	34300-2K	34800
17700Z	34700	34800-2K
17700-2K	34700Z	34801-2K
34134A	34700-2K	34900
34234	34711-2K	342000

Replacement Filter





Condenser and Evaporator Thread Chasers

- NOT for Use with Stainless Steel Material
- Repairs Internal & External Threads
- Repairs Damaged Threads on Condensers, Accumulators, Evaporators and Hose Assemblies.
- Coverage for Domestic and Import Vehicles.

SAE Thread Chasers

Part # 2754

Size Included:

5/8"-18 1"-14,
3/4"-16 1 1/16"-14
7/8"-14



Metric Thread Chasers

Part # 2755

Size Included:

M14 x 1.5 M22 x 1.5
M16 x 1.5 M24 x 1.5
M18 x 1.5 M27 x 2
M20 x 1.5 M28 x 1.5



Fan Clutch Tool Kit

Part # 7925

- Five wrenches, five holding tools, and one pull handle to give you broad coverage of GM, Ford, and Chrysler vehicles that use a fan clutch.



Serpentine Belt Tool Kit

Part # 7975

Includes:

- 13mm, 14mm, 15mm, 16mm, and 18mm Sockets.
- 13mm, 15mm, 16mm Sockets in Handle and Extensions.
- 13mm, 14mm, and 15mm Crowfoot Wrenches.
- 3/8" and 1/2" Square Drive Socket.
- 1 Pull Handle and 2 Extensions.

Kit used for installing and removing serpentine belts on most GM, Ford and Chrysler vehicles.



Compressor Clutch Hub Puller Installer Kit

- Use with GM, Ford, Chrysler and Imports.
- Compressor Guide Included.
- Molded Storage Case.

Part # 2925



Compressor Manufacturer	Remover	Installer
Harrison GM DA-6, HR-6, V5	2936 Nut & Arbor	2952 Nut & Bearing 2956 Arbor (Do Not Use Washer)
A-6 & Earlier R4	2931 Nut & Arbor	2952 Nut & Bearing 2958 Arbor
R4	2931 Nut 2937 Arbor	2952 Nut & Bearing 2956 Arbor (Do Not Use Washer)
Nippondenso Ford / Chrysler A590, C171 & FS-6	2939 Nut 2936 Arbor	2952 Nut & Arbor (Use Washer)
FS-6 w/ special 24mm x 2.0	2939 Nut & Arbor	2952 Nut & Arbor (Use Washer)
New Style	2931 Nut & Arbor	2952 Nut & Arbor (Use Washer)
Sanden	2941 Puller Plate & Arbor	
York/Tecumseh HR980	2939 Nut 2936 Arbor	2952 Nut & Arbor (Use Washer)
Zexel/Mitsubishi CH Series	2943 Arbor 2941 Puller Plate	





MasterSeal Tool Assortment Kit

Part # 7600

- Includes tools to service shaft seals on most popular compressors.



GM DA6 Carbon Shaft Seal Tool Kit

Part # 7611

- For use in changing carbon shaft seals in DA6 compressors.



Ford FS6, Chrysler C171, and Nippondenso 6P Shaft Seal Tool Kit

Part # 7612



Sanden Shaft Seal Tool Kit

Part # 7615

- Includes tools to service shaft seals on Sanden SD507, 508, and 510 Compressors.



Sanden Shaft Seal Tool Kit

Part # 7616

- Includes tools to service shaft seals on Sanden 505 and 575 compressors.



Diesel Kiki Shaft Seal Tool Kit

Part # 7617



Hitachi & Mitsubishi Shaft Seal Tool Kit

Part # 7618



Nippondenso 10PA Shaft Seal Tool Kit

Part # 7619



Chrysler 6C17 Shaft Seal Tool Kit

Part # 7620



FJC

Air Conditioning Products

A/C Tools



Ford FX15/ FS10 Shaft Seal Tool Kit

Part # 7621



GM Metric Clutch Remover/Installer Kit

Part # 7635

- For servicing GM compressors using metric threads.



SnapRing Pliers

Part # 7696



External

Part # 7697



Internal

GM Pre 1980 Compressor Clutch Installer/Removal Kit

Part # 7634

- For servicing GM compressors using standard threads.



Compressor Clutch Puller Kit

Part # 7510

- Safely Remove and Install Compressor Clutches on Most Vehicles.
- Molded Case Included.



Replacement Parts:	
Part #	Description
7530	Universal Puller Body
7534	Puller Arbor
7537	Universal Clutch Puller Jaws
7732	Universal Pilot

Master Compressor Clutch Puller Kit

Part # 7500

Replacement Parts:	
Part #	Description
7530	Universal Puller Body
7534	Puller Arbor
7537	Universal Clutch Puller Jaws
7538	Clutch Puller Jaws
7540	GM DA6 & V5 Clutch Puller Jaws
7542	GM R4 Clutch Puller Jaws
7544	Sanden 505 Pulley and Clutch Jaws
7743	Sanden Pulley and Clutch Remover Jaws
7725	GM A6 & V5 Clutch Puller Jaws
7728	Diesel Kiki Shaft Protector Pilot
7732	Universal Pilot
7735	Nippondenso Shaft Protector



- Essential Kit for Safely Removing and Installing Compressor Clutches.
- Coverage for Domestic and Import Vehicles.
- Molded Case Included.

Denso Clutch Hub Tools



Part # 7512
Set of 3 Denso Clutch
Hub Tools



Part # 7514
Clutch Tool for Denso
7SEU Clutch



Part # 7516
Clutch Tool for Denso
6SEU Clutch



Part # 7518
Clutch Tool for Denso
5SER09C Clutch











Spring Lock Coupler Tools

Assortment Includes



Part # 2875
9 Piece Spring Lock
Coupler Tool Set.

-  **Part #2885** 3/4" A/C Springlock Coupler
-  **Part #2884** 5/8" A/C Springlock Coupler
-  **Part #2883** 1/2" A/C Springlock Coupler
-  **Part #2882** 3/8" A/C Springlock Coupler
-  **Part #2886** 3/8" Fuel Line Coupler
-  **Part #2887** 1/2" Fuel Line Coupler
-  **Part #2877** 3/8" Fuel Line Coupler
-  **Part #2876** 5/16" Fuel Line Coupler
-  **Part #2878** Transmission Line Coupler

R12 Dye Injector

Part # 2728



- Inject 1/4 ounce of Fluorescent Dye into an A/C system under pressure or during service.

R12 Oil Injector R134a Oil Injector

Part # 2729

Part # 2734



- Inject up to 2 oz. of Refrigerant oil into an Automotive A/C System Under Pressure.
- Part # 2736 - Replacement Oring.

Part # 2730



Hand Turn Dye Injector



- Inject 1/4 to 1/2 ounce of Fluorescent Dye into a R12 or R134a A/C System under pressure.

Part # 2737 (Injector Replacement Oring)
Part # 6074 (Coupler Oring Repair Kit)

R134a Dye Injector

Part # 2733



- Inject 1/4 ounce of Fluorescent Dye into an A/C system under pressure or during service.

R134a/R12 2 oz. Handturn Oil and Dye Injector

Part #2732



- 2 oz. refillable R134a/R12 oil and UV dye injector.
- Add oil or UV dye to system without adding refrigerant.

R134a 2 oz. Flow Through Oil Injector

Part # 2738



- Easy to use.
- Connects to vehicle's R134a service port.
- Uses R134a and Manifold Gauge set to inject oil into vehicle.

Part # 2736 - Replacement Oring



Universal Compressor Clutch Holding Tool



- Holds Compressor Clutch Hub during Removal/Installation.

Part # 2910

Digital Thermometer

Part # 2795



- Fast, Easy and Accurate.
- Auto Shutoff.
- Includes Battery.
- Fahrenheit or Celsius.
- Includes Pocket Holder with Clip.

1" Dial Thermometer

Part # 2792



- 1" Face with Magnifying Lens.
- 0° to 220°F.
- Includes Pocket Holder with Clip.

1 3/4" Dial Thermometer

Part # 2790



- Easy to read 1 3/4" Face.
- 0° to 220°F.
- Includes Pocket Holder with Clip.

Don't Forget Your U-Charge Hose & R134a Stop Leak!

R134a Stop Leak w/Red Dye

Part # 9140

- Seals Leaks in Orings & Gaskets.
- R134a Refrigerant.
- Sealers with Oring Conditioners.
- Red Leak Detection Dye.
- No UV Light Necessary to View the Dye.
- Will not harm vehicle A/C system or Refrigerant Recovery or Charging Equipment.



R134a to R12 Conversion Hoses

Part # 6080 - Set of 3 conversion hoses

- Eliminates need for multiple manifold gauge sets.
- Save on unnecessary equipment cost.

Part # 6081

Part # 6082

Part # 6083



Directions:

Remove R134a couplers on Red and Blue R134a hoses and replace with Red and Blue FJC conversion hoses with 1/4" fittings. Attach Yellow conversion hose to end of R134a Yellow hose on R134a manifold.



Fin Comb

Part # 2740

- Straightens Bent Fins on A/C Condensers and Radiators to increase air flow.

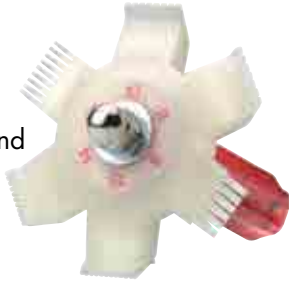

R12 Service Port Thread Chaser

Part # 2742

- Cleans Threads on R12 Service Ports.



Valve Core Tool Large

Part # 2744

- Remove and Install Large Bore Valve Cores in Late Model Vehicles.



HD Large Bore Valve Core Tool

Part # 2743

- Removes and Installs Large Bore Valve Cores up to 10mm in HD Applications.
- Extended Length for Hard to Reach Areas.



Valve Core Tool Standard

Part # 2745

- Removes and Installs Standard Valve Cores.



Socket for Bridgeport Style Retrofit Adapters. (8 Sided)

Part # 2746



Low Side

Socket for Bridgeport Style Retrofit Adapters. (8 Sided)

Part # 2748



High Side

A/C Insulation Tape

- Insulates & Seal Parts.
- Protect Parts from Heat.
- Sticks to Metal or Rubber.

Part # 2862
30 ft. Roll



Part # 2863
3 ft. Roll



Heating and A/C Manual

Part # 2819

- Provides general information on A/C theory, system maintenance, trouble shooting & specifications.



Hose Cutter

Part # 2840

- Cuts Refrigerant and other Rubber Hose up to 1 1/2" OD.





Heavy Duty PVC and Hose Cutter

Part # 2843

- Ratchet Design for Easy Use.
- Cuts Rubber Hose and PVC up to 1 1/4" OD.



Replacement Blade
Part # 2844

Oring Pick

Part # 2860

- Will not Scratch Metal Surfaces which can cause Refrigerant Leaks.

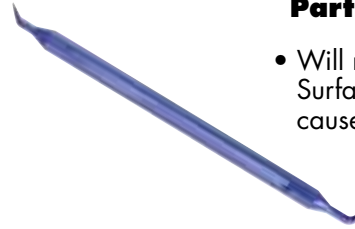

Quick Disconnect Tool Set

Part # 2874 Set of 5

- For disconnecting fuel & transmission lines.



Ford Spring Lock Coupler Tools

Part # 2880 Set of 4



3/8"

Part # 2882

1/2"

Part # 2883

5/8"

Part # 2884

3/4"

Part # 2885

R134a Can Tap

Part # 6030

- Brass Dispensing Valve for R134a Cans with 1/2" ACME Fittings.



Replacement Seal **Part # 6041**

R12 Side Can Tap

Part # 6031

- Slides Over R12 Cans for Quick and Easy Charging.



Replacement Seal **Part # 6039**

R134a Side Can Tap

Part # 6034

- Slides Over R134a Cans for Quick and Easy Charging.



Replacement Seal **Part # 6039**

R134a U-Charge Hose

Part # 6035

- Reusable Brass Dispensing Valve with Hose and R134a Quick Coupler.
- Charge A/C Systems with R134a Cans with 1/2" ACME Fitting.

Replacement Oring **Part # 4008**
Replacement Seal **Part # 6041**



R134a/R12 Side Can Tap

Part # 6040

- For Use with All R134a or R12 Small Cans of Refrigerant or Oil Charge.



Replacement Seal **Part # 6039**



Commercial Refrigeration & HVAC Tools

Mini Tubing Cutters

Part # 20206



- Compact design allows easy access in tight spaces.
- Cuts copper, brass and aluminum tubing.

Part # 20206 - 1/8" to 5/8"

Part # 20208 - 1/8" to 7/8"

Part # 20209 - 3/8" to 1 1/8"

Part # 20231 - Replacement Cutting Wheel

Heavy Duty Tubing Cutter

Part # 20212



- Precise screw feed adjustment maintains exact pressure during cutting.
- Includes spare cutter wheel and fold away reamer.

Part # 20212 - 1/8" to 1 1/8"

Part # 20214 - 1/4" to 1 5/8"

Part # 20232 - Replacement Cutting Wheel

Part # 20233 - Replacement Cutting Wheel for Stainless Steel

Ratchet Type Tubing Cutter

Part # 20217



- Ratchet design allows heavy duty cutting action in restricted places.
- Thumb turn design for quick adjustment.

Part # 20217 - 1/4" to 7/8"

Part # 20218 - 5/16" to 1 1/8"

Part # 20232 - Replacement Cutting Wheel

PVC Inner - Outer Reamer

Part # 20283



- Removes burrs from inside and outside of tubing.
- 1/8" to 1 5/8"

Tube Deburring Tool

Part # 20285

Part # 20287



- Quickly remove sharp edges on all sizes of tubing.
- Part # 20289 - Replacement Blades**



45° Flaring Tool Set

Part # 20310



- For 45° Flaring of 3/16", 1/4", 5/16", 3/8", 7/16", 1/2", and 5/8" O.D. soft copper, aluminum and brass tubing.

Universal Flare/Burnish Tool

Part # 20315



- Flare and burnish soft copper, aluminum and brass tubing. 3/16" to 5/8" O.D.

Universal Swaging Punch

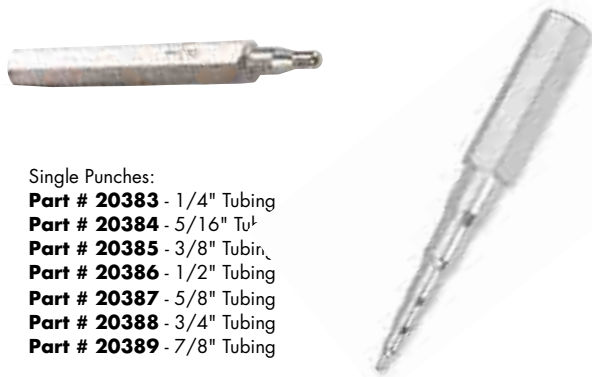

Single Punches:

- Part # 20383** - 1/4" Tubing
- Part # 20384** - 5/16" Tubing
- Part # 20385** - 3/8" Tubing
- Part # 20386** - 1/2" Tubing
- Part # 20387** - 5/8" Tubing
- Part # 20388** - 3/4" Tubing
- Part # 20389** - 7/8" Tubing

Part # 20382

5 in 1 punch 1/4" to 5/8" O.D.

Spring Tube Benders

- For fast bending of soft copper and aluminum tubing.



Single Tubes:

- Part # 20591** - 1/4" Tubing
- Part # 20592** - 5/16" Tubing
- Part # 20593** - 3/8" Tubing
- Part # 20594** - 7/16" Tubing
- Part # 20595** - 1/2" Tubing
- Part # 20596** - 5/8" Tubing
- Part # 20597** - 3/4" Tubing

Part # 20590

5 pc. set 1/4" to 5/8"

3 in 1 Tube Bender

Part # 20520



- For 1/4", 5/16" and 3/8" Tubing
- Up to 180° Bends.

Level Tube Bender

- Bend soft copper, brass, aluminum, steel and other metal tubing.
- Calibrated scale for angles.
- Up to 180° Bends.

Part #	Tube Dia.	Bend Radius
20525	1/2"	1 1/2"
20526	5/8"	2 1/4"
20527	3/4"	3"
20528	7/8"	3 1/4"



Part # 20526

Reversible Ratchet Wrench

Part # 20732

- Fits compressor and acetylene valves.

Part #	Description
20732	9/16", 1/2" hex, 1/4" and 3/16" square



Pinch-Off Pliers

Part # 20748

- Pinch off leaks in emergency situations.



Metal Fin Comb





















Part # 20709

- Straighten and clean condenser and evaporator fins.





Refer to Application Guide for Applications

 Part # 3004 (5 pack) Part # 3104 (single pack) Color: Grey Porous Make: GM Dia: 0.062	 Part # 3005 (5 pack) Part # 3105 (single pack) Color: Black Porous Make: GM Dia: 0.057	 Part # 3006 (5 pack) Part # 3106 (single pack) Color: Blue Make: GM Dia: 0.067	 Part # 3008 (5 pack) Part # 3108 (single pack) Color: Orange T-top Make: GM Dia: 0.057
 Part # 3011 (5 pack) Part # 3111 (single pack) Color: White Make: GM Dia: 0.072	 Part # 3012 (5 pack) Part # 3112 (single pack) Color: Black T-top Make: GM Dia: 0.072	 Part # 3013 (5 pack) Part # 3113 (single pack) Color: Yellow T-top Make: GM Dia: 0.062	 Part # 3014 (5 pack) Part # 3114 (single pack) Color: Yellow Make: Volvo Dia: 0.062
 Part # 3016 (5 pack) Part # 3116 (single pack) Color: Blue Make: Ford Dia: 0.067	 Part # 3017 (5 pack) Part # 3117 (single pack) Color: Red Make: Ford Dia: 0.062	 Part # 3018 (5 pack) Part # 3118 (single pack) Color: Green Make: Ford Dia: 0.052	 Part # 3019 (5 pack) Part # 3119 (single pack) Color: Orange Make: Ford Dia: 0.059
 Part # 3020 (5 pack) Part # 3120 (single pack) Color: Brown Make: Ford Dia: 0.047	 Part # 3021 (5 pack) Part # 3121 (single pack) Color: Black Make: Ford Dia: 0.072	 Part # 3024 (5 pack) Part # 3124 (single pack) Color: Purple T-top Make: Chrysler Dia: 0.062	 Part # 3026 (5 pack) Part # 3126 (single pack) Color: Orange T-top Make: Chrysler Dia: 0.057
 Part # 3036 (5 pack) Part # 3136 (single pack) Color: Grey Make: Toyota Dia: 0.072	 Part # 3038 (5 pack) Part # 3138 (single pack) Color: Orange Make: Audi Dia: 0.057	 Part # 3131 Variable Orifice Tube	 Part # 3133 Variable Orifice Tube "T" Top

Orifice Tube Repair Kits

Part # 3043



- Used to Replace Orifice Tube at Inlet Section of Evaporator Core.

Part # 3044



- Used to Replace Orifice Tube which is made into Liquid Line.

Orifice Tube Remover/Installer Kit

Part # 2830

- Easily Removes Orifice Tubes without Damage.
- Storage Case Included.
- For Standard and "T" Top Orifice Tubes.



Orifice Tubes & Service Items



Master Orifice Tube Assortment

Part # 3000

- Complete Coverage of All Orifice Tubes Available.
- 20 Part Numbers - 36 Pieces.
- Includes Removal/Installer Tool.

Kit Contains:

1 Part # 3004	2 Part # 3011	2 Part # 3016	2 Part # 3020	2 Part # 3036
1 Part # 3005	2 Part # 3012	2 Part # 3017	2 Part # 3021	2 Part # 3038
2 Part # 3006	2 Part # 3013	2 Part # 3018	2 Part # 3024	10 Part # 4051
2 Part # 3008	2 Part # 3014	2 Part # 3019	2 Part # 3026	1 Removal/Installer Tool



Orifice Tube Assortment

Part # 3007

- Contains 11 Different Orifice Tubes Currently Used.
- 22 Orifice Tubes in Assortment.
- Expanded Coverage.

Kit Contains:

2 Part # 3008	2 Part # 3014	2 Part # 3019
2 Part # 3011	2 Part # 3016	2 Part # 3020
2 Part # 3012	2 Part # 3017	2 Part # 3024
2 Part # 3013	2 Part # 3018	



Heavy Duty Orifice Tube Assortment

Part # 3009

- Contains 8 Different Orifice Tubes Currently Used.
- 38 Orifice Tubes in Assortment.
- Expanded Coverage.

Kit Contains:

8 Part # 3011
8 Part # 3012
2 Part # 3014
8 Part # 3016
4 Part # 3017
4 Part # 3019
2 Part # 3020
2 Part # 3024



Liquid Line Filter Screen Assortment

Part # 3198

- 7 Part Numbers - 13 Pieces.



Kit Contains:

Part # 3187
Part # 3190
Part # 3191
Part # 3192
Part # 3193
Part # 3194
Part # 3195

Replacement Screens

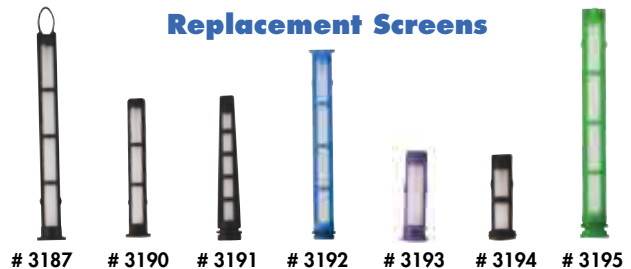

Service Items

OE R134a Replacement Service Ports

Part # 2607(5 pk)
Part # 2557(1 pk)

Low Side
OE R134a
Service Port
m13 x 1.0



Uses Cap #2613

Part # 2608(5 pk)
Part # 2558(1 pk)

Low Side
Ford
m10 x 1.25



Uses Cap #2614

Part # 2609(5 pk)
Part # 2574(1 pk)

High Side
OE R134a
Service Port
m15 x 1.0



OEM uses Cap #2617
Aftermarket
Uses Cap #2615

Part # 2610(5 pk)
Part # 2576(1 pk)

High Side
Ford, GM
Chrysler
m12 x 1.5



Uses Cap #2615

OE R134a Replacement Service Port Assortment

Part # 2685

- Replacement R134a Service Ports.
- 4 Part Numbers-8 Pieces.

Kit contains:
2- Part # 2607
2- Part # 2609
2- Part # 2608
2- Part # 2610



OE R134a Replacement Service Port Cap Assortment

Part # 2686

- Replacement R134a Service Ports and Caps.
- 7 Part numbers – 14 Pieces.

2 – Part # 2607	2 – Part # 2613
2 – Part # 2608	2 – Part # 2614
2 – Part # 2609	2 – Part # 2615
2 – Part # 2610	





Service Items

R12 & R134a Valve Cores

 Standard Part # 2672	 GM High Flow Part # 2673	 JRA High Flow Part # 2674	 Volvo Part # 2675	 8mm Low Side Part # 2676	 10mm High Side Part # 2677	 Import/ Domestic 2003 and up Part # 2678
---	---	--	--	---	---	--

R12 & R134a Service Port Caps

 Part # 2611 Red High Side 15mm Fitting 10 mm x 1.25	 Part # 2612 Red High Side 17mm Fitting 10 mm x 1.25	 Part # 2613 Blue Low Side 15mm Fitting 9 mm x 1	 Part # 2614 Blue Low Side 15mm Fitting 8 mm x 1.0 Threads	 Part # 2615 Red High Side 17mm Fitting 8 mm x 1.0 Threads	 Part # 2616 Black High Side 17mm Fitting 10 mm x .75	 Part # 2617 Red High Side 17mm Fitting 10 mm Threads	 Part # 2621 R12 Cap 1/4"	 Part # 2622 R12 Cap 3/16"
--	--	--	--	--	---	---	--	---

 Part # 2623 Blue Low Side Import 9mm x 1.0	 Part # 2624 Blue High Side Import 10mm x 1.25	 Part # 2619 1/2" ACME	 Part # 2626 Black Low Side 15mm x 1.25 8 mm Threads
---	--	--	--

Master Replacement Cap and Valve Core Assortment

Part # 2683

- 18 Part Numbers-88 Pieces

Kit contains:

5- Part # 2617	3- Part # 2673
5- Part # 2611	5- Part # 2674
5- Part # 2612	2- Part # 2675
5- Part # 2613	4- Part # 2676
5- Part # 2614	4- Part # 2677
5- Part # 2615	
5- Part # 2616	



Master Valve Core Remover & Installer Kit

Part # 2750



- Remove & Install replacement valve cores WITHOUT losing refrigerant charge.
- Fits standard and larger valve cores.
- Services R12 & R134a service ports.

R12 & R134a Valve Core Assortments

Part # 2682



- 6 Part Numbers - 20 Pieces.

Kit Contains:

10 Part # 2672	2 Part # 2675
2 Part # 2673	2 Part # 2676
2 Part # 2674	2 Part # 2677

Part # 2680



- 5 Different Valve Cores.
- Valve Core Tools for Standard and Large Valve Cores.
- 7 Part Numbers - 37 Pieces.

Kit Contains:

20 Part # 2672	4 Part # 2677
3 Part # 2673	1 Part # 2744
4 Part # 2674	1 Part # 2745
4 Part # 2676	

Part # 2663



- R12 and R134a Service Port Caps.
- 5 Different Valve Cores.
- Valve Core Tools For Standard and Large Valve Cores.
- 12 Part Numbers - 85 Pieces.

Kit Contains:

10 Part # 2614	10 Part # 2622	5 Part # 2676
10 Part # 2615	20 Part # 2672	5 Part # 2677
5 Part # 2617	3 Part # 2673	1 Part # 2744
10 Part # 2621	5 Part # 2674	1 Part # 2745

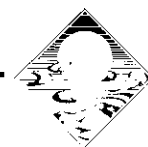

Compressor Clutch Bearings

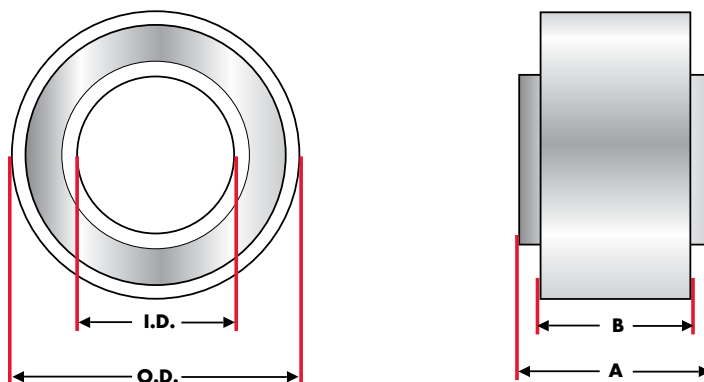

Part#	Description	ID		OD		A		B	
		MM	Inch	MM	Inch	MM	Inch	MM	Inch
3641	Compressor Clutch Bearing	12	0.472	28	1.102	8	0.315	8	.0135
3643	Compressor Clutch Bearing	30	1.181	52	2.047	22	0.866	22	0.866
3645	Compressor Clutch Bearing	30	1.181	55	2.165	13	0.512	13	0.512
3647	Compressor Clutch Bearing	30	1.181	55	2.165	23	0.906	23	0.906
3648	Compressor Clutch Bearing	32	1.260	55	2.165	23	0.906	23	0.906
3650	Compressor Clutch Bearing	35	1.378	50	1.969	20	0.787	20	0.787
3653	Compressor Clutch Bearing	35	1.378	52	2.047	20	0.787	20	0.787
3657	Compressor Clutch Bearing	35	1.378	52	2.047	22	0.866	22	0.866
3659	Compressor Clutch Bearing	35	1.378	55	2.165	20	0.787	20	0.787
3662	Compressor Clutch Bearing	40	1.575	57	2.244	24	0.945	24	0.945
3664	Compressor Clutch Bearing	40	1.575	62	2.441	20.6	0.811	24	0.945
3667	Compressor Clutch Bearing	40	1.575	62	2.441	20.6	0.811	20.6	0.811
3668	Compressor Clutch Bearing	40	1.575	62	2.441	24	0.945	24	0.945
3671	Compressor Clutch Bearing	40	1.575	66	2.598	24	0.945	24	0.945
3674	Compressor Clutch Bearing	30	1.181	47	1.850	20	0.787	20	0.787

Compressor Shaft Seal Kits

<p>Part # 3551 GM A6, R4 Shaft Seal Kit</p>	<p>Part # 3554 GM R4, DA6 (Except 1983-1984 Two Piece Type Seal), HR6, HR6HE, V5 Teflon Lip shaft Seal Kit</p>	<p>Part # 3558 GM HT, HR6, HR6HE, V5 Standard Shaft OD, Double Lip Shaft Seal Kit</p>
<p>Part # 3561 Daiwoo V5, GM V5, V7 (some models) HNBR Lip Seal Kit</p>	<p>Part # 3565 York 6 Bolt Seal Kit (7/32 Hole)</p>	<p>Part # 3566 York 6 Bolt Seal Kit (9/32 Hole)</p>
<p>Part # 3567 Tecumseh HG1000 Large Bearing Shaft Seal Kit</p>	<p>Part # 3569 Sanden SD507, SD508, SD510 Shaft Seal Kit</p>	<p>Part # 3570 Ford FS10, FX15 Lip Seal Kit with Shaft Protector</p>
<p>Part # 3576 Nippondenso 7SB16C Lip Seal Kit</p>	<p>Part # 3580 Nippondenso 10PA15, 10PA17, 10PA20 Shaft Seal Kit</p>	<p>Part # 3582 Nippondenso 10P13, 10P15, Shaft Seal Kit (Wave Spring Type Carbon Seal)</p>
<p>Part # 3585 Diesel KIKI DCV-11A, Nippondenso 10PA HNBR Lip Seal Kit</p>	<p>Part # 3588 Sanden SD5, SD7, 5H, 7H, SD7V16, SD7B10 Lip Seal Kit Oring Type</p>	



Switches

Air Conditioning Control Switches

Refer to Application Guide for Switch Requirements

Chrysler

 R134a Part # 3271 Dodge 12mm Switchport 1994 - 1996	 R134a Part # 3274 Dodge Cycling Pressure Switch	 R134a Part # 3276 Dodge 12mm Switchport 1994 - 1996	 R134a Part # 3277 Dodge Cycling Pressure Switch 1998 - 2003	 R134a Part # 3288 Lincoln Cycling Pressure Switch 2004 - 2005
 R134a Part # 3321 Compressor High Pressure Cut-off Switch Chrysler 1994 - 2009	 R134a Part # 3340 Chrysler High Pressure Cut Out Switch	 R134a Part # 3341 Dodge/Jeep High Pressure Cut Out Switch 1994 - 1998	 R134a Part # 3342 Chrysler/Mercedes Pressure Transducer 1994 - 2007	

Ford

 R12 Part # 3214 1/4" Switchport Ford 1981 - 1993	 R134a Part # 3280 12mm Switchport Ford 1993 - 1995	 R134a Part # 3282 12mm Switchport Ford 2002 - 2005	 R134a Part # 3283 12mm Switchport Ford 2002 - 2005	 R134a Part # 3284 12mm Switchport Ford 1995 - 1997
 R134a Part # 3285 12mm Switchport Ford 2003 - 2005	 R134a Part # 3286 12mm Switchport Ford 2006 - 2007	 R134a Part # 3287 12mm Switchport Ford 1996 - 1997	 R134a Part # 3349 Pressure Cut Out Switch Ford, Lincoln, Mazda High 2005 - 2009	 R134a Part # 3358 Ford High Pressure Cut Off Switch
 R134a Part # 3411 Binary Switch Ford 1994 - 2003	 R134a Part # 3412 Binary Switch Ford 2002 - 2005	 R134a Part # 3414 Binary Switch Ford, Lincoln, Mercury 2000 - 2007	 R134a Part # 3415 Ford Binary, HPCO, Cooling Fan Switch	

Switches



Air Conditioning Control Switches

Refer to Application Guide for Switch Requirements

GM

 <p>R12 Part # 3203 1/4" Switchport GM 1978 - 1993</p>	 <p>R12 Part # 3205 1/4" Switchport GM 1989 - 1993</p>	 <p>R134a Part # 3262 12mm Switchport GM 1993 - 1995</p>	 <p>R134a Part # 3264 12mm Switchport GM 1994 - 1996</p>	 <p>R134a Part # 3265 10mm Switchport GM 1994 - 1997</p>	 <p>R134a Part # 3266 12mm Switchport GM 1994 - 2000</p>
 <p>R134a Part # 3267 12mm Switchport GM 1994 - 2005</p>	 <p>R134a Part # 3312 Low Pressure Cut-off Switch - GM 1986 - 2001</p>	 <p>R134a Part # 3319 Compressor High Side Low Pressure Switch GM 1985 - 2005</p>	 <p>R134a Part # 3320 Compressor High Pressure Cut-off Switch GM Denso 1999 - 2007</p>	 <p>R134a Part # 3322 GM White Compressor Pressure Switch</p>	 <p>R134a Part # 3328 GM Red Compressor Pressure Switch</p>
 <p>R134a Part # 3331 GM Compressor Low Pressure Cut off Switch for High Side</p>	 <p>R134a Part # 3375 GM Compressor Cooling Fan Switch</p>	 <p>R134a Part # 3378 GM Radiator Fan Switch 1984-1992</p>	 <p>R134a Part # 3379 GM Fan Switch 1983-2001</p>		

Air Conditioning Control Switch Assortment

Part # 3475

- 21 Most Popular A/C Control Switches

*Kit Contains:

1 ea. Part # 3262	1 ea. Part # 3280	1 ea. Part # 3320
1 ea. Part # 3264	1 ea. Part # 3282	1 ea. Part # 3322
1 ea. Part # 3265	1 ea. Part # 3283	1 ea. Part # 3328
1 ea. Part # 3266	1 ea. Part # 3284	1 ea. Part # 3331
1 ea. Part # 3267	1 ea. Part # 3285	1 ea. Part # 3358
1 ea. Part # 3274	1 ea. Part # 3286	1 ea. Part # 3415
1 ea. Part # 3276	1 ea. Part # 3287	1 ea. Part # 3418





Switches

Air Conditioning Control Switches

Refer to Application Guide for Switch Requirements

Imports

 <p>R134a Part # 3418 Toyota, Lexus High/Low Pressure Switch 28 PSI/45 PSI</p>	 <p>R134a Part # 3420 Acura, Lexus 1988-1994 Trinary, Cooling Fan, HPCO, LPCO Switch</p>	 <p>R134a Part # 3421 Acura, Toyota 1993-1999 Trinary, Cooling Fan, HPCO, LPCO Switch</p>	 <p>R134a Part # 3423 Lexus, Toyota 1992-1999 Binary, HPCO, LPCO Switch</p>	 <p>R134a Part # 3424 Toyota 1990-2005 Trinary, HPCO, LPCO Switch</p>
 <p>R134a Part # 3426 BMW 1994-2008 Trinary, HPCO, LPCO Cooling Fan</p>	 <p>R134a Part # 3428 Acura, Honda 1993-1999 Binary, HPCO, LPCO Switch</p>	 <p>R134a Part # 3429 Nissan, Infinity 1997-2005 Trinary, HPCO, LPCO Switch</p>	 <p>R134a Part # 3430 Volkswagon 1992-2003 Trinary, HPCO, LPCO Cooling Fan</p>	 <p>R134a Part # 3431 Audi/Volkswagon 1997- 2003 Trinary, HPCO, LPCO Cooling Fan</p>
 <p>R134a Part # 3433 Acura, Honda Binary Switch</p>	 <p>R134a Part # 3435 Acura, Honda, Subaru 1996-2002 Binary Switch</p>	 <p>R134a Part # 3499 Manual Thermostat 16" CAP. Tube</p>		





Electrical Connectors (Pigtails)



Compressor Clutch Connectors (Pigtails)

 <p>Part # 12159 Chrysler C171 A/C Compressor Coil Adapter to Nippondenso Style Harness Connectors.</p>	 <p>Part # 12170 Toyota Pigtail, Oval Connector for Nippondenso, 3 terminal</p>	 <p>Part # 12171 Toyota Pigtail, Oval Connector for Nippondenso, 3 terminal</p>	 <p>Part # 12172 Toyota Pigtail Adapter - Converts Round Connector to Oval Connector</p>	 <p>Part # 12181 Nissan Compressor Clutch Pigtail - Nihon Compressor</p>
 <p>Part # 12188 BMW / Nippondenso Compressor Clutch Coil Connector - one wire</p>	 <p>Part # 12189 Sanden VW / Nippondenso Compressor Clutch Coil Connector</p>	 <p>Part # 12190 Nippondenso 10S17F / 10S20F Compressor Clutch Coil Connector</p>	 <p>Part # 12191 Nippondenso A/C Compressor Speed Sensor - Black Housing - 2 Wire</p>	 <p>Part # 12192 Nippondenso 10P17C (Acura) A/C Compressor Clutch Coil Connector - White Housing - One wire</p>
 <p>Part # 12193 Diesel Kiki A/C Compressor Clutch Coil Connector - Black Housing</p>	 <p>Part # 12194 Matsushita NL1300 AE4 Compressor Clutch Coil Connector - White/Natural Housing - 4 Wire</p>	 <p>Part # 12195 Mitsubishi FX80 / 105V Compressor Clutch Coil Connector - Black Housing - 3 Wire</p>	 <p>Part # 12196 TCVC Clutch Coil Pigtail</p>	 <p>Part # 12197 SD7/SD6 Citroen/Peugeot Coil Pigtail</p>
 <p>Part # 12198 VW Sd7V16 Coil Pigtail (for 1" coil only)</p>	 <p>Part # 12199 Nippondenso, Mercedes, BMW Coil Connector</p>	 <p>Part # 12201 6E171 two pin Plug</p>	 <p>Part # 12203 VW/Audi Clutch Coil Connector</p>	

Switch Connectors (Pigtails)

 <p>Part # 12301 Universal Low Pressure Switch - 2 Spade terminals</p>	 <p>Part # 12302 Coolant Temperature Sensor Pigtail</p>	 <p>Part # 12305 Universal Blower Pigtail - 5 Terminal Connector</p>	 <p>Part # 12308 Universal Push Button A/C On/Off Switch / Blower Fan / Hitachi A/C Compressor Clutch Coil, White/ Natural Housing - 2 wire</p>
--	---	---	---



Electrical Connectors (Pigtails)















Compressor Clutch Connectors (Pigtails)

				
Part # 12109 Universal A/C Compressor Clutch Coil Male Bullet Type Connector - 12" Long	Part # 12111 Universal Female Bullet Type Connector - Mate for part # PT-4002 - 12" Long	Part # 12120 GM 12" Coil Extension for GM Compressors, Female to Male Spade Connector	Part # 12121 GM Coil Pigtail with Spade Connectors	Part # 12122 GM 8mm Connector for Compressor Coil
				
Part # 12123 GM 8mm Pin Connector to Spade Connector adapter for Compressor Coil	Part # 12124 GM 8mm Spade Connector to Pin Connector adapter for Compressor Coil	Part # 12126 GM A/C Clutch Coil Connector with Diode - spade Type Terminals - 90° angled boot - black housing - 2 wire type	Part # 12128 GM Compressor Ground - Black Housing - One Wire	Part # 12131 GM Sanden A/C Compressor Clutch Coil Connector with Diode
				
Part # 12132 GM A/C Compressor Clutch Coil Connector without Diode - Spade Terminals - 2 Wire	Part # 12133 Ford / GM Custom Pigtail Connector - 2 wire without Diode	Part # 12134 Ford / GM Custom Pigtail Connector - 2 Wire with Diode	Part # 12141 Ford pigtail for Compressor Coil	Part # 12142 Ford Pigtail Connector for Sanden Compressor Coil
				
Part # 12143 Ford FS6 / 6E / 6P / 10 / 10P Compressor Clutch Coil Connector Housing - Black Housing	Part # 12144 Ford FX15 / FS10 Compressor Clutch Coil Connector Housing - Grey Housing	Part # 12146 Ford / Sanden / Nippondenso A/C Clutch Coil - White/Natural Housing - One wire	Part # 12155 Chrysler Pigtail for Compressor Coil	Part # 12156 Chrysler 2 Pin Connector for Compressor 10S & 10PA
				
Part # 12157 Chrysler Single Pin Connector for Compressor 10PA				

Electrical Connectors (Pigtails)











Switch Connectors (Pigtails)

 <p>Part # 12309 Universal Black Plastic Housing for Spade Type Low / High Pressure Binary & Trinary Switches</p>	 <p>Part # 12310 Universal Pressure Switch Connector - 2 Wire</p>	 <p>Part # 12311 Pressure Cycling Switch, Low / High Pressure Switch - 48" Wire - Black Rubber Housing</p>	 <p>Part # 12350 GM Low Pressure Switch Pigtail, Black, 1985-1995</p>	 <p>Part # 12351 GM High Pressure Switch Pigtail, Red, 1985-1996</p>
 <p>Part # 12352 GM Compressor Pressure Switch Pigtail - 1985-1992</p>	 <p>Part # 12358 GM Coolant Temperature Sensor Switch - Black - 2 Wire Type</p>	 <p>Part # 12359 GM Clutch Switch - Black Housing - 2 Wire</p>	 <p>Part # 12362 GM A/C Compressor Feed/ Low Coolant Sensor - Black Housing - one wire</p>	 <p>Part # 12401 Ford Switch Pigtail - 4 Pin Terminal Connector</p>
 <p>Part # 12408 Ford Compressor Cycling Switch Pigtail, 2 spade terminal - 1981-1999</p>	 <p>Part # 12409 Ford Engine Cooling Fan Pigtail, 1984-1989</p>	 <p>Part # 12415 Ford Coolant Sensor Pigtail - 1980-1996</p>	 <p>Part # 12417 Ford Blower Switch - Black Housing</p>	



Relay Wiring Connectors (Pigtails)

 <p>Part # 12615 Relay Pigtail Repair Kit</p>	 <p>Part # 12616 Relay Pigtail - 3 Terminal Connector</p>	 <p>Part # 12618 Relay Pigtail w/ Mounting Bracket - 4 or 5 Terminal Connector</p>
--	--	---

Cooling Fan/Blower Wiring Connectors (Pigtails)

 <p>Part # 12661 GM Relay - Pins Connector 1986 - 1993</p>	 <p>Part # 12669 GM Relay - 5 Terminal Connector 1965 - 1994</p>	 <p>Part # 12671 GM Fan Relay - 5 Wire Black Housing</p>	 <p>Part # 12674 Ford Fan Control Relay Repair Kit</p>
 <p>Part # 12753 Ford Blower Switch Pigtail</p>	 <p>Part # 12854 GM Radiator Fan Motor Pigtail</p>	 <p>Part # 12892 Ford Radiator Fan Motor Pigtail</p>	 <p>Part # 12893 Ford Blower Motor Resistor Pigtail - 4 Terminal Connector</p>

Universal Wiring Connectors (Pigtails)

 <p>Part # 12809 Wiring Harness w/o Bracket BOSCH</p>	 <p>Part # 12925 Universal Fuse Holder for Spade Type fuse - Black Housing</p>
---	--

See FJC Battery Testers and Accessories on Page 68 in the Tools and Equipment Section



Service Item Assortment

Pro-Series Service Item Assortment

All Orings are High Temperature Green HNBR



Part # 4400



Oring Wall Chart Included

Kit Contains:

Orings, Gaskets, Sealing Washers, Keyways, Shims, Fittings, Caps and Orifice Tubes, etc.

- Sturdy Case.
- Total 1006 Pieces.
- Total 203 Part Numbers.
- 12 Compartments for Easy Storage.

Kit Contains:

4 Part # 2602	20 Part # 4010	5 Part # 4082	5 Part # 4177	5 Part # 4223	2 Part # 4318
4 Part # 2603	25 Part # 4012	5 Part # 4086	5 Part # 4178	5 Part # 4225	2 Part # 4319
2 Part # 2604	5 Part # 4015	5 Part # 4087	5 Part # 4179	5 Part # 4226	2 Part # 4320
2 Part # 2606	5 Part # 4016	5 Part # 4088	5 Part # 4182	5 Part # 4227	2 Part # 4321
1 Part # 2608	5 Part # 4017	5 Part # 4089	5 Part # 4183	5 Part # 4228	2 Part # 4324
1 Part # 2610	5 Part # 4018	5 Part # 4090	5 Part # 4186	5 Part # 4229	2 Part # 4325
2 Part # 2611	5 Part # 4026	5 Part # 4091	5 Part # 4187	10 Part # 4230	2 Part # 4326
2 Part # 2612	5 Part # 4028	5 Part # 4093	5 Part # 4189	10 Part # 4232	2 Part # 4327
2 Part # 2613	5 Part # 4030	5 Part # 4094	25 Part # 4190	20 Part # 4233	2 Part # 4328
5 Part # 2614	5 Part # 4032	5 Part # 4095	5 Part # 4191	5 Part # 4234	5 Part # 4335
5 Part # 2615	5 Part # 4038	5 Part # 4096	25 Part # 4192	5 Part # 4235	5 Part # 4345
2 Part # 2616	5 Part # 4040	5 Part # 4097	25 Part # 4193	5 Part # 4237	5 Part # 4346
2 Part # 2617	5 Part # 4042	5 Part # 4116	25 Part # 4194	5 Part # 4238	1 Part # 6041
5 Part # 2618	5 Part # 4043	5 Part # 4118	5 Part # 4195	5 Part # 4239	1 Part # 6047
5 Part # 2620	5 Part # 4044	5 Part # 4120	5 Part # 4196	5 Part # 4240	1 Part # 6049
5 Part # 2621	5 Part # 4045	5 Part # 4122	5 Part # 4197	5 Part # 4241	10 Part # 6050
5 Part # 2622	5 Part # 4050	4 Part # 4130	25 Part # 4198	5 Part # 4242	1 Part # 6051
10 Part # 2672	5 Part # 4051	4 Part # 4131	5 Part # 4199	5 Part # 4243	1 Part # 6052
2 Part # 2673	5 Part # 4052	4 Part # 4140	5 Part # 4201	5 Part # 4245	10 Part # 6055
4 Part # 2674	2 Part # 4053	4 Part # 4142	5 Part # 4202	5 Part # 4246	5 Part # 6060
4 Part # 2676	2 Part # 4054	4 Part # 4143	5 Part # 4203	5 Part # 4247	5 Part # 6061
4 Part # 2677	2 Part # 4060	4 Part # 4144	5 Part # 4204	5 Part # 4248	5 Part # 6063
2 Part # 3011	2 Part # 4061	4 Part # 4150	5 Part # 4205	2 Part # 4250	10 Part # 6065
1 Part # 3012	2 Part # 4062	4 Part # 4151	5 Part # 4206	1 Part # 4252	2 Part # 6066
1 Part # 3014	2 Part # 4063	4 Part # 4154	5 Part # 4207	1 Part # 4253	
2 Part # 3016	2 Part # 4064	4 Part # 4158	5 Part # 4208	1 Part # 4254	
1 Part # 3017	2 Part # 4065	4 Part # 4160	5 Part # 4209	1 Part # 4255	
1 Part # 3018	2 Part # 4066	4 Part # 4162	5 Part # 4211	1 Part # 4256	
1 Part # 3019	2 Part # 4070	4 Part # 4166	5 Part # 4214	1 Part # 4258	
1 Part # 3020	2 Part # 4071	5 Part # 4168	5 Part # 4215	5 Part # 4305	
1 Part # 3024	2 Part # 4072	5 Part # 4170	5 Part # 4216	5 Part # 4306	
5 Part # 4002	2 Part # 4073	5 Part # 4171	5 Part # 4218	5 Part # 4307	
5 Part # 4004	2 Part # 4074	5 Part # 4172	5 Part # 4219	5 Part # 4308	
25 Part # 4006	2 Part # 4075	5 Part # 4173	5 Part # 4220	5 Part # 4312	
25 Part # 4008	5 Part # 4078	5 Part # 4175	5 Part # 4221	2 Part # 4315	
	5 Part # 4080	5 Part # 4176	5 Part # 4222	2 Part # 4317	

"The Ultimate Assortment... for the A/C Specialist"

Service Item Assortments

Service Item Assortment

Deluxe Service Item Assortment



For Vehicles 1995-2012

Kit Contains:

Part # 4415

Orings, Gaskets, Sealing Washers, Caps and other service items.

- Total 612 Pieces.
- Total 120 Part Numbers.
- Convenient Carrying Case.



Oring Wall Chart Included



Kit Contains:

1 Part # 2608	20 Part # 4008	2 Part # 4062	2 Part # 4122	20 Part # 4190	5 Part # 4219	5 Part # 4247
1 Part # 2610	20 Part # 4010	2 Part # 4070	2 Part # 4128	20 Part # 4192	5 Part # 4220	5 Part # 4248
2 Part # 2611	5 Part # 4012	2 Part # 4071	2 Part # 4129	20 Part # 4193	5 Part # 4222	1 Part # 4250
2 Part # 2612	10 Part # 4026	2 Part # 4072	2 Part # 4132	5 Part # 4194	5 Part # 4223	1 Part # 4253
2 Part # 2613	5 Part # 4028	2 Part # 4073	2 Part # 4133	5 Part # 4196	5 Part # 4226	1 Part # 4254
4 Part # 2614	5 Part # 4030	2 Part # 4074	4 Part # 4150	5 Part # 4198	5 Part # 4228	
4 Part # 2615	5 Part # 4032	2 Part # 4075	4 Part # 4151	5 Part # 4199	5 Part # 4229	
2 Part # 2616	5 Part # 4034	2 Part # 4078	4 Part # 4154	5 Part # 4202	5 Part # 4230	
2 Part # 2617	10 Part # 4038	5 Part # 4080	4 Part # 4158	5 Part # 4203	5 Part # 4232	
2 Part # 2623	5 Part # 4040	5 Part # 4086	4 Part # 4166	5 Part # 4204	5 Part # 4233	
2 Part # 2624	5 Part # 4042	5 Part # 4087	5 Part # 4170	10 Part # 4206	5 Part # 4234	
5 Part # 2672	5 Part # 4043	5 Part # 4088	5 Part # 4171	10 Part # 4208	5 Part # 4235	
2 Part # 2673	5 Part # 4045	15 Part # 4090	5 Part # 4172	5 Part # 4209	5 Part # 4237	
1 Part # 2674	5 Part # 4050	5 Part # 4093	5 Part # 4178	5 Part # 4210	5 Part # 4238	
2 Part # 2675	5 Part # 4051	5 Part # 4094	5 Part # 4182	5 Part # 4211	5 Part # 4239	
2 Part # 2676	10 Part # 4052	5 Part # 4096	10 Part # 4183	5 Part # 4213	5 Part # 4240	
2 Part # 2677	1 Part # 4053	2 Part # 4116	5 Part # 4186	5 Part # 4215	5 Part # 4241	
5 Part # 4002	1 Part # 4054	2 Part # 4118	5 Part # 4187	5 Part # 4216	5 Part # 4243	
20 Part # 4006	2 Part # 4060	2 Part # 4120	5 Part # 4189	5 Part # 4218	5 Part # 4246	
	2 Part # 4061					

Deluxe Oring Assortment



Oring Wall Chart Included

Part # 4275

- 34 Most Popular Sizes
- 350 Pieces
- Green HNBR



Kit Contains:

10 Part # 4002	10 Part # 4038	10 Part # 4187	5 Part # 4206
20 Part # 4006	10 Part # 4040	20 Part # 4190	10 Part # 4208
20 Part # 4008	10 Part # 4042	10 Part # 4191	5 Part # 4215
20 Part # 4010	10 Part # 4043	5 Part # 4193	10 Part # 4218
20 Part # 4012	10 Part # 4051	5 Part # 4194	5 Part # 4230
10 Part # 4026	10 Part # 4052	10 Part # 4196	10 Part # 4238
10 Part # 4028	10 Part # 4080	10 Part # 4197	5 Part # 4240
10 Part # 4030	10 Part # 4170	5 Part # 4203	5 Part # 4241
10 Part # 4032	10 Part # 4186		

Oring Assortment

Part # 4278

- 18 Most Popular Sizes for all models
- 180 Pieces
- Green HNBR



Oring Wall Chart Included



Kit Contains:

10 Part # 4002	10 Part # 4028	10 Part # 4190
10 Part # 4006	10 Part # 4032	10 Part # 4191
10 Part # 4008	10 Part # 4038	10 Part # 4194
10 Part # 4010	10 Part # 4042	10 Part # 4196
10 Part # 4012	10 Part # 4043	10 Part # 4208
10 Part # 4026	10 Part # 4187	10 Part # 4218

Top Four Oring Assortment

Part # 4279

- 4 Most Popular Sizes
- 100 Pieces
- Green HNBR



Kit Contains:

25 Part # 4006
25 Part # 4008
25 Part # 4010
25 Part # 4012

Service Item Assortments



Oring Assortments

Chrysler Oring & Gasket Assortment - 1989 and Earlier

Part # 4286

20 Part Numbers

- 187 Pieces.
- Green HNBR.
- Metal Gaskets.

Oring Wall Chart Included



Kit Contains:

- | | | |
|----------------|---------------|----------------|
| 15 Part # 4006 | 5 Part # 4142 | 10 Part # 4187 |
| 15 Part # 4008 | 5 Part # 4143 | 15 Part # 4190 |
| 15 Part # 4010 | 5 Part # 4144 | 15 Part # 4203 |
| 15 Part # 4012 | 5 Part # 4150 | 15 Part # 4240 |
| 15 Part # 4030 | 8 Part # 4151 | 5 Part # 4305 |
| 2 Part # 4053 | 8 Part # 4158 | 5 Part # 4306 |
| 2 Part # 4054 | 5 Part # 4166 | |

Chrysler Oring Assortment - 1990 to 2009

Part # 4287

27 Part Numbers

- 204 Pieces.
- Green HNBR.
- Metal Gaskets.

Oring Wall Chart Included



Kit Contains:

- | | | | |
|----------------|---------------|----------------|----------------|
| 15 Part # 4006 | 2 Part # 4118 | 4 Part # 4166 | 5 Part # 4211 |
| 15 Part # 4008 | 2 Part # 4120 | 20 Part # 4190 | 5 Part # 4213 |
| 10 Part # 4030 | 4 Part # 4128 | 10 Part # 4192 | 10 Part # 4230 |
| 2 Part # 4073 | 4 Part # 4129 | 10 Part # 4193 | 10 Part # 4233 |
| 2 Part # 4074 | 4 Part # 4132 | 10 Part # 4194 | 10 Part # 4240 |
| 10 Part # 4080 | 4 Part # 4133 | 10 Part # 4203 | 10 Part # 4243 |
| 2 Part # 4116 | 4 Part # 4150 | 10 Part # 4210 | |

Ford Oring Assortment

Part # 4288

- 20 Part Numbers.
- 200 Pieces.
- Orings, Shims, Bushings.
- Green HNBR.

Oring Wall Chart Included



Kit Contains:

- | | | |
|----------------|----------------|----------------|
| 15 Part # 4006 | 15 Part # 4190 | 10 Part # 4234 |
| 15 Part # 4008 | 10 Part # 4192 | 10 Part # 4241 |
| 15 Part # 4010 | 10 Part # 4193 | 10 Part # 4248 |
| 10 Part # 4012 | 10 Part # 4194 | 6 Part # 4308 |
| 10 Part # 4028 | 10 Part # 4198 | 2 Part # 4325 |
| 10 Part # 4078 | 10 Part # 4209 | 2 Part # 4326 |
| 10 Part # 4170 | 10 Part # 4225 | |

Ford Spring Lock Coupling Assortment

Part # 4290

- 4 Sizes - Orings.
- 4 Sizes - Garter Springs.
- Green HNBR.
- 60 Pieces.

Kit Contains:

- | | |
|----------------|---------------|
| 10 Part # 4006 | 5 Part # 4116 |
| 10 Part # 4008 | 5 Part # 4118 |
| 10 Part # 4010 | 5 Part # 4120 |
| 10 Part # 4012 | 5 Part # 4122 |



Ford Metric Spring Lock Coupling Assortment

Part # 4291

- 4 Sizes - Metric Orings.
- 4 Sizes - Garter Springs.
- Green HNBR.
- 60 Pieces.

Kit Contains:

- | | |
|---------------|----------------|
| 5 Part # 4116 | 10 Part # 4192 |
| 5 Part # 4118 | 10 Part # 4193 |
| 5 Part # 4120 | 10 Part # 4194 |
| 5 Part # 4122 | 10 Part # 4198 |



GM Oring Assortment

Part # 4293

- 18 Part Numbers.
- 180 Pieces.
- Green HNBR.

Oring Wall Chart Included



Kit Contains:

- | | | |
|----------------|----------------|----------------|
| 10 Part # 4006 | 10 Part # 4030 | 10 Part # 4050 |
| 10 Part # 4008 | 10 Part # 4032 | 10 Part # 4186 |
| 10 Part # 4010 | 10 Part # 4038 | 10 Part # 4189 |
| 10 Part # 4012 | 10 Part # 4040 | 10 Part # 4190 |
| 10 Part # 4026 | 10 Part # 4042 | 10 Part # 4196 |
| 10 Part # 4028 | 10 Part # 4043 | 10 Part # 4197 |

GM Sealing Washer Assortment

Part # 4294

- 3 Most Popular GM Sealing Washers.
- Insert for Sealing Washers.
- 4 Part Numbers.
- 24 Pieces.

Kit Contains:

- | | |
|---------------|---------------|
| 6 Part # 4060 | 6 Part # 4062 |
| 6 Part # 4061 | 6 Part # 4071 |



Oring Assortments



Slim Line Sealing Washer Assortment

Part # 4295

- 4 sizes - 20 Pieces.
- GM Sealing Washers.

Kit Contains:

- 5 Part # 4072
- 5 Part # 4073
- 5 Part # 4074
- 5 Part # 4075



Master Sealing Washer Assortment

Part # 4296

- 15 Part Numbers - 47 Pieces.
- GM and Chrysler Sealing Washers.

Kit Contains:

- 3 Part # 4053
- 3 Part # 4054
- 3 Part # 4060
- 3 Part # 4061
- 3 Part # 4062
- 2 Part # 4063
- 2 Part # 4064
- 2 Part # 4065
- 2 Part # 4066
- 4 Part # 4070
- 4 Part # 4071
- 4 Part # 4072
- 4 Part # 4073
- 4 Part # 4074
- 4 Part # 4075



Oring Wall Chart Included

Metric Oring Assortment

Part # 4298

- 12 Popular Metric Orings.
- 120 Pieces.
- Green HNBR.

Kit Contains:

- 10 Part # 4006
- 10 Part # 4008
- 10 Part # 4010
- 10 Part # 4012
- 10 Part # 4028
- 10 Part # 4052
- 10 Part # 4080
- 10 Part # 4094
- 10 Part # 4186
- 10 Part # 4187
- 10 Part # 4190
- 10 Part # 4203



Large Metric Oring Assortment

Part # 4299

- 18 Popular Metric Orings.
- 180 Pieces.
- Green HNBR.

Kit Contains:

- 10 Part # 4006
- 10 Part # 4008
- 10 Part # 4010
- 10 Part # 4012
- 10 Part # 4028
- 10 Part # 4052
- 10 Part # 4080
- 10 Part # 4094
- 10 Part # 4183
- 10 Part # 4186
- 10 Part # 4187
- 10 Part # 4190
- 10 Part # 4203
- 10 Part # 4206
- 10 Part # 4208
- 10 Part # 4218
- 10 Part # 4233
- 10 Part # 4238



Oring Wall Chart Included

Top Eight Oring Assortment

Part # 4895

- 8 Most Popular Sizes.
- 200 Pieces.
- Green HNBR.
- Attractive Retail Packaging.



Retail Oring Assortment

Part # 4897

- 8 Most Popular Sizes.
- 24 Pieces.
- Green HNBR.
- Attractive Retail Packaging.



Honda & Toyota Oring Assortment

Part # 4297

- Total 126 Pieces.
- Total 15 Part Numbers.
- Most Popular Import Orings and Gaskets.
- Green HNBR.

Kit Contains:

- 10 Part # 4006
- 10 Part # 4008
- 10 Part # 4010
- 10 Part # 4012
- 10 Part # 4028
- 10 Part # 4080
- 10 Part # 4186
- 10 Part # 4187
- 10 Part # 4190
- 10 Part # 4203
- 10 Part # 4233
- 10 Part # 4238
- 2 Part # 4250
- 2 Part # 4252
- 2 Part # 4255



Oring Wall Chart Included

Deluxe Metric/Import Oring Assortment

Part # 4300

- 34 Popular Metric Orings.
- 350 Pieces.
- Green HNBR.

Kit Contains:

- 15 Part # 4006
- 10 Part # 4008
- 10 Part # 4010
- 10 Part # 4012
- 10 Part # 4028
- 10 Part # 4043
- 10 Part # 4052
- 10 Part # 4080
- 10 Part # 4088
- 10 Part # 4094
- 10 Part # 4178
- 10 Part # 4182
- 10 Part # 4183
- 10 Part # 4186
- 10 Part # 4187
- 10 Part # 4189
- 15 Part # 4190
- 10 Part # 4192
- 10 Part # 4203
- 10 Part # 4204
- 10 Part # 4206
- 10 Part # 4208
- 10 Part # 4209
- 10 Part # 4211
- 10 Part # 4214
- 10 Part # 4215
- 10 Part # 4218
- 10 Part # 4222
- 10 Part # 4233
- 10 Part # 4237
- 10 Part # 4238
- 10 Part # 4239
- 10 Part # 4240
- 10 Part # 4246



Oring Wall Chart Included



Service Item Assortments

Heavy Duty Service Item Assortments

Part # 4465

- Total 542 Pieces.
- Total 118 Part Numbers.
- Durable Wall Mount Storage Case Included.

Kit Contains:

O-rings, Gaskets,
Sealing Washers,
Caps and other
service items.



HD Oring Wall Chart Included



Kit Contains:

2 Part # 2602	1 Part # 3024	5 Part # 4042	2 Part # 4075	5 Part # 4193	2 Part # 4324
2 Part # 2603	5 Part # 4002	10 Part # 4043	5 Part # 4080	5 Part # 4194	2 Part # 4327
4 Part # 2612	5 Part # 4004	5 Part # 4044	5 Part # 4082	5 Part # 4195	2 Part # 4328
4 Part # 2613	10 Part # 4006	5 Part # 4046	5 Part # 4090	5 Part # 4198	2 Part # 4345
4 Part # 2614	15 Part # 4008	5 Part # 4050	5 Part # 4091	5 Part # 4201	2 Part # 4346
4 Part # 2615	15 Part # 4010	5 Part # 4051	4 Part # 4116	5 Part # 4210	5 Part # 4361
2 Part # 2616	15 Part # 4012	10 Part # 4052	4 Part # 4118	5 Part # 4211	5 Part # 4362
4 Part # 2617	2 Part # 4015	2 Part # 4060	4 Part # 4120	5 Part # 4212	5 Part # 4364
10 Part # 2672	2 Part # 4016	2 Part # 4061	4 Part # 4122	10 Part # 4218	5 Part # 4365
4 Part # 2675	2 Part # 4017	2 Part # 4062	5 Part # 4170	5 Part # 4219	5 Part # 4370
4 Part # 2676	2 Part # 4018	2 Part # 4063	5 Part # 4171	5 Part # 4225	5 Part # 4371
4 Part # 2677	5 Part # 4026	2 Part # 4064	5 Part # 4172	5 Part # 4230	5 Part # 4372
4 Part # 3011	5 Part # 4028	2 Part # 4065	5 Part # 4175	5 Part # 4233	5 Part # 4373
4 Part # 3012	5 Part # 4030	2 Part # 4066	5 Part # 4179	5 Part # 4234	5 Part # 4374
2 Part # 3014	10 Part # 4032	2 Part # 4070	5 Part # 4182	10 Part # 4235	5 Part # 4375
4 Part # 3016	5 Part # 4034	2 Part # 4071	5 Part # 4186	5 Part # 4241	5 Part # 4376
2 Part # 3017	5 Part # 4035	5 Part # 4072	5 Part # 4187	5 Part # 4248	5 Part # 4377
2 Part # 3019	5 Part # 4036	2 Part # 4073	5 Part # 4189	2 Part # 4315	4 Part # 4381
2 Part # 3020	5 Part # 4038	2 Part # 4074	5 Part # 4190	2 Part # 4317	4 Part # 4382
1 Part # 3021	5 Part # 4040	5 Part # 4075	5 Part # 4192	2 Part # 4319	



Heavy Duty Truck A/C Service Assortment

Part # 4463

- 23 Part numbers
- 114 Pieces
- Contains popular sealing washers, A/C Orings, valve cores and service caps.



HD Oring Wall Chart Included

Kit Contains:

4 Part # 2612	2 Part # 2677	10 Part # 4235
4 Part # 2613	10 Part # 4006	4 Part # 4376
4 Part # 2614	10 Part # 4008	4 Part # 4377
4 Part # 2615	10 Part # 4010	2 Part # 4381
4 Part # 2616	4 Part # 4072	2 Part # 4382
4 Part # 2626	4 Part # 4073	
10 Part # 2672	4 Part # 4074	
2 Part # 2675	5 Part # 4091	
2 Part # 2676	5 Part # 4218	



Heavy Duty Truck A/C Service Assortment

Part # 4464

- 15 Part numbers
- 150 Pieces
- Contains popular sealing washers, A/C Orings, valve cores and service caps.



HD Oring Wall Chart Included

Kit Contains:

10 Part # 2614	10 Part # 4006	10 Part # 4032
10 Part # 2615	10 Part # 4008	10 Part # 4043
10 Part # 2672	10 Part # 4010	10 Part # 4052
10 Part # 2673	10 Part # 4012	
10 Part # 2676	10 Part # 4026	
10 Part # 2677	10 Part # 4030	



Heavy Duty Oring Assortments & Sealing Washers



Heavy Duty Truck Service Item Assortment

Part # 4450

• Total 74 Pieces - 16 Part number

Kit Contains:

- 1 Part # 2207
- 5 Part # 2613
- 5 Part # 2617
- 6 Part # 2676
- 6 Part # 2677
- 1 Part # 2743
- 5 Part # 4055
- 5 Part # 4056
- 5 Part # 4062
- 5 Part # 4072
- 5 Part # 4073
- 5 Part # 4074
- 5 Part # 4075
- 5 Part # 4370
- 5 Part # 4371
- 5 Part # 4372



HD Oring Wall Chart Included



Heavy Duty Truck Sealing Washer Oring Assortment

Part # 4454

• Total 135 Pieces - 18 Part number

Kit Contains:

- 10 Part # 4006
- 10 Part # 4008
- 10 Part # 4010
- 10 Part # 4012
- 10 Part # 4043
- 10 Part # 4044
- 10 Part # 4046
- 5 Part # 4055
- 5 Part # 4056
- 5 Part # 4072
- 5 Part # 4073
- 5 Part # 4074
- 5 Part # 4075
- 10 Part # 4218
- 10 Part # 4230
- 5 Part # 4370
- 5 Part # 4371
- 5 Part # 4372



HD Oring Wall Chart Included



Heavy Duty Truck Sealing Washer Assortment

Part # 4458

• Total 65 Pieces - 8 Part number

Kit Contains:

- 10 Part # 4062
- 10 Part # 4072
- 10 Part # 4073
- 10 Part # 4074
- 10 Part # 4075
- 5 Part # 4370
- 5 Part # 4371
- 5 Part # 4372



Heavy Duty Truck A/C Oring Assortment

Part # 4460



- 6 Part numbers
- 55 Pieces
- Contains popular A/C Orings

Kit Contains:

- 10 Part # 4006
- 10 Part # 4008
- 10 Part # 4010
- 10 Part # 4012
- 5 Part # 4043
- 10 Part # 4052



Heavy Duty Truck Stat Seals Kit

Part # 4459

• Single job kit

Kit Contains:

- 2 Part # 4373
- 2 Part # 4374
- 2 Part # 4375
- 2 Part # 4376
- 2 Part # 4377



4373
#6 Stat Seal



4374
#8 Stat Seal



4375
#10 Stat Seal
(Evaporator)



4376
#12 Stat Seal



4377
Stat Seal
(Evaporator)

























Orings

All Orings are actual size

All Orings are High Temperature Green HNBR



















 Part # 4221 GM & Asian Imports	 Part # 4206 Ford Combination Valve Liquid Bleed Tube Connection Nissan #6 Hose/Expansion Valve/Capillary Tube VIR Liquid Bleed Line	 Part # 4052 GM Capillary Tube	 Part # 4183 Metric Hose and Drier, Mitsubishi FX 105V rear housing, Sanden TR70 oil drain bolt
 Part # 4208 GM Oil Tube & Filler Bolt Diesel Kiki DKS16H Oil Drain Plug Nissan #8 Hose Fitting/Drier	 Part # 4223 Metric - GM & Asian Imports	 Part # 4186 Toyota Liquid Line/Drier #5 Hose Fitting	 Part # 4080 Ford Combination Valve STV Manifold Oil Port Use with Chrysler Gasket #4132
 Part # 4182 Metric Captive Oring - Nissan, Calsonic, Honda	 Part # 4222 Metric - Asian Imports	 Part # 4051 Ford/GM Orifice Tube	 Part # 4192 Thicker metric for Ford #6 Spring Lock Couplers
 Part # 4006 #6 Hose Ford Expansion Valve Seal Ford #6 Springlock Oring Nissan #10 Hose Fitting/Drier VIR Pickup Tube/Condenser Line	 Part # 4227 Metric - Imports	 Part # 4026 #6 GM "Captured" Fitting Oring Ford Combination Valve Evaporator Manifold Oil Port Ford Expansion Valve	 Part # 4226 Metric - Imports
 Part # 4195 Metric 7.4mm - Imports	 Part # 4229 Metric - Asian - Imports	 Part # 4228 Metric - Imports	 Part # 4189 Ford 12 mm switchport - Metric (cycling pressure switch)

Orings



All Orings are actual size

All Orings are
High Temperature Green HNBR





















 <p>Part # 4214 Metric - Asian - Compressor Manifold</p>	 <p>Part # 4240 Diesel Kiki DK515CH Pressure Relief Valve</p>	 <p>Part # 4190 #6 ATCO Compression Fitting Chrysler 6C17 Pressure Relief Valve Ford Clutch Cycling Pressure Switch GM A6/R4 Pressure Relief Valve GM V5 Control Valve (Inside) Sanden SD7B10 Oil Plug/Service Port Toyota Pressure Switch York 206/210 Oil Plug</p>	 <p>Part # 4199 Metric 9mm - Imports</p>
 <p>Part # 4171 #8 Metric - Dual Oring</p>	 <p>Part # 4088 GM & Asian Imports</p>	 <p>Part # 4193 Metric Oring for Ford #8 Spring Lock Coupler</p>	 <p>Part # 4196 Metric #8 GM Captured Oring</p>
 <p>Part # 4038 #8 GM "Dual" Fitting Oring (1/2")</p>	 <p>Part # 4234 Ford Hose Fitting - 1/2 #8 Peanut</p>	 <p>Part # 4008 #8 Hose Fitting GM V5 Control Valve (Inside Center) Ford #8 Springlock Fitting Nissan #12 Hose Fitting and Condenser Discharge Line Toyota Discharge Line</p>	 <p>Part # 4028 #8 GM "Captured" Fitting Oring</p>
 <p>Part # 4087 Metric - Imports</p>	 <p>Part # 4201 Metric 10.7mm - Imports</p>	 <p>Part # 4238 Diesel Kiki DKS16H Oil Fill Plug Hitachi A5000/MJS170 Suction/Discharge Valve</p>	 <p>Part # 4172 #10 Metric - Dual Oring</p>
 <p>Part # 4187 Metric Captive Oring - Nissan, Calsonic</p>	 <p>Part # 4040 #10 GM "Dual" Fitting Oring (5/8")</p>	 <p>Part # 4002 ATCO #8 Compression Fitting</p>	



Orings

All Orings are actual size

All Orings are High Temperature Green HNBR





















 <p>Part # 4210 Use with Chrysler Gasket # 4128</p>	 <p>Part # 4242 Matsushita S1150X3 Sensor Housing</p>	 <p>Part # 4218 Nissan Condenser Liquid Line VIR Sightglass Mitsubishi FX80 Discharge Port</p>	 <p>Part # 4191 Metric 13.1mm Imports</p>
 <p>Part # 4194 Metric Oring for Ford #10 Spring Lock Coupler</p>	 <p>Part # 4197 Metric #10 GM "Captured" Oring</p>	 <p>Part # 4248 Ford Hose Fitting - 5/8" #10 Peanut</p>	 <p>Part # 4239 Metric - Imports</p>
 <p>Part # 4205 Metric 14mm, Mitsubishi Compressor</p>	 <p>Part # 4089 Metric Chrysler</p>	 <p>Part # 4010 #10 Hose Fitting Ford #10 Springlock Oring Nissan Evaporator Suction Line Sanden TR70 Suction Port Toyota Suction Line</p>	 <p>Part # 4030 #10 GM "Captured" Fitting Oring Matsushita S1150X3 Carbon Shaft Seal</p>
 <p>Part # 4219 Metric - Imports</p>	 <p>Part # 4096 GM & Asian Imports</p>	 <p>Part # 4213 Use with Chrysler Gasket # 4133</p>	 <p>Part # 4173 #12 Metric - "Dual" Oring</p>
 <p>Part # 4203 Metric "Captive" Oring - Nissan, Calsonic, Honda</p>	 <p>Part # 4211 Metric - Asian - Compressor Manifold Use with Chrysler Gasket # 4129</p>	 <p>Part # 4237 Nippondenso TV10CA Carbon Seal</p>	 <p>Part # 4215 Nissan Compressor Discharge Flange</p>

Orings



All Orings are actual size

All Orings are High Temperature Green HNBR











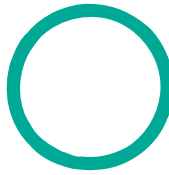
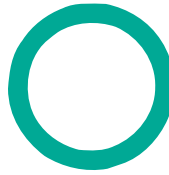

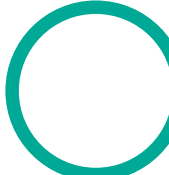

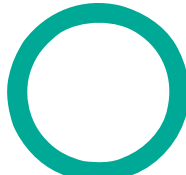
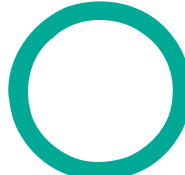
 <p>Part # 4042 #12 GM "Dual" Fitting Oring ATCO #10 Compression Fitting Nissan Suction/Discharge (York Reciprocating Compressor)</p>	 <p>Part # 4032 #12 GM "Captured" Fitting Oring Chrysler A590/C171 Carbon Shaft Seal Diesel Kiki DKS13G Carbon Shaft Seal Ford FS6 Carbon Shaft Seal GM A6/R4 Carbon Shaft Seal Nihon DKV14C Carbon Seal Mitsubishi FX80 Suction Port</p>	 <p>Part # 4204 Metric "Captive" Oring - Nip- pondenso Compressor - Nissan, Calsonic, Honda</p>	 <p>Part # 4097 Metric - Asian Imports</p>
 <p>Part # 4093 Metric - Asian Imports</p>	 <p>Part # 4241 Ford Hose Fitting - 3/4" #12 Peanut</p>	 <p>Part # 4198 Metric Oring for Ford #12 Spring Lock Coupler</p>	 <p>Part # 4095 Metric - Asian Imports</p>
 <p>Part # 4091 Metric - Imports</p>	 <p>Part # 4243 Chrysler</p>	 <p>Part # 4090 Metric - Chrysler & Imports</p>	 <p>Part # 4220 Mercedes w/ Tabs</p>
 <p>Part # 4094 Metric - Chrysler & Asian Imports</p>	 <p>Part # 4012 #12 Hose Fitting Ford #12 Springlock Oring GM V5 Control Valve (outside center) VIR Expansion Valve (lower) VIR Expansion Valve Outlet VIR Compressor Suction Line Connection</p>	 <p>Part # 4230 Diesel Kiki DKS16H Carbon Shaft Seal Hitachi Service Valve Keihin 150L/150R Carbon Shaft Seal/Suction Port Mitsubishi FX105V Sensor Sanden TR90 Discharge Port Sanden Pad Mount Discharge</p>	 <p>Part # 4176 Volvo Metric</p>
 <p>Part # 4202 Metric 16.9mm Nippondenso Compressor</p>	 <p>Part # 4216 Metric - Asian - Compressor Manifold</p>	 <p>Part # 4086 Metric - Chrysler & Asian Imports</p>	 <p>Part # 4175 Metric 17mm</p>

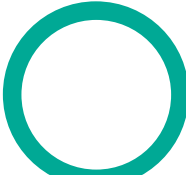

Orings

All Orings are actual size

All Orings are High Temperature Green HNBR

 <p>Part # 4004 ATCO #12 Compression Fitting</p>	 <p>Part # 4232 Diesel Kiki DKS15BH/DKS15CH Discharge Port GM V5 Control Valve (outside) Behr Bosch Carbon Shaft Seal Nihon DKV14B Carbon Shaft Seal Sanden TR105 Discharge Port</p>	 <p>Part # 4168 Chrysler Expansion Valve</p>	 <p>Part # 4246 Metric - Imports</p>
 <p>Part # 4078 Oval Oring Ford FS6 Suction/Discharge Port</p>	 <p>Part # 4233 Hitachi SWP123/SWP167 Service Valve Nippondenso 6P148 Suction/Discharge Port Sanden TR90 Suction Port Sanden Pad Mount Suction</p>	 <p>Part # 4245 Matsushita S1150X3 Sensor/NL1300AA4 Metal Seat</p>	 <p>Part # 4170 Chrysler A590/C171 Suction/Discharge Port Ford FS6 Suction/Discharge Port Nippondenso 6P127A/6P127B/6E171A/ 6P134/10P13/10P15 Suction/Discharge Port</p>
 <p>Part # 4209 Metric 19.8mm, Diesel Kiki</p>	 <p>Part # 4082 Chrysler EPR-ETR Ford Combination Valve STV Ford Expansion Valve</p>	 <p>Part # 4235 Diesel Kiki DKS15BH/DKS13G Suction Port Ford Combination Valve Evaporator Manifold to STV Manifold Ford Expansion Valve Mitsubishi FX105V Metal Shaft Seal Seat Sanden TR105 Suction Port</p>	 <p>Part # 4207 Sanden shaft seal seat. Diesel Kiki</p>
 <p>Part # 4050 Chrysler 6C17 Switch Port GM Superheat/Pressure Switch Port</p>	 <p>Part # 4043 Chrysler 6C17 Lip Seal GM A6/DA6/HR6/HR6HE/R4/V5 Suction/Discharge Port Nippondenso Lip Seal For 10PO8E/10PA15/10PA17/10PA20 Nissan Hose Manifold to York Rotary Compressor</p>	 <p>Part # 4179 GM & Imports</p>	 <p>Part # 4247 Metric - Imports</p>

Orings



All Orings are actual size

All Orings are
High Temperature Green HNBR

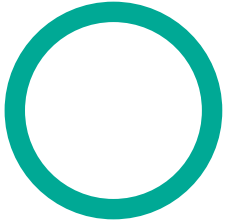

Part # 4178
Sanden shaft seal seat

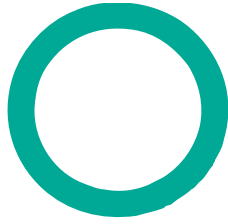

Part # 4044
Chrysler Expansion Valve

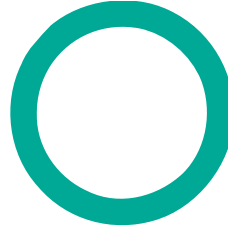

Part # 4045
Oval Oring
GM Suction/Discharge Port

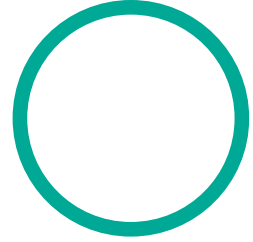

Part # 4046
Sanden Compressor Suction

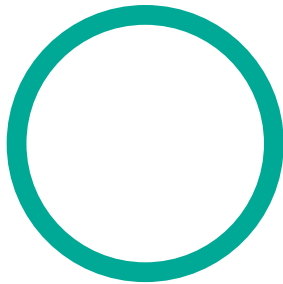

Part # 4177
GM Compressor shaft seal seat

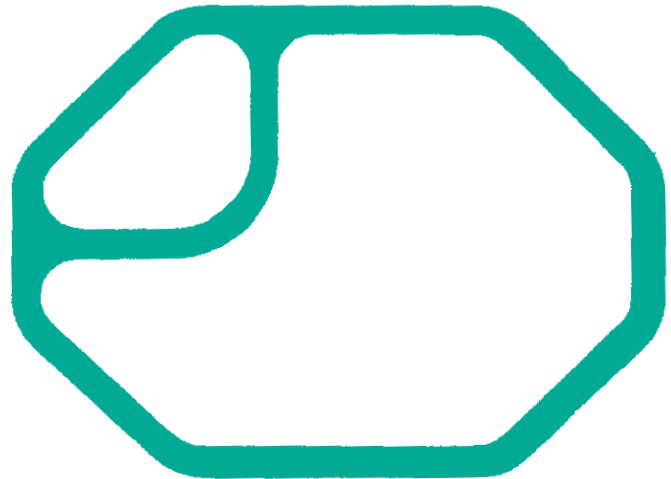

Part # 4250
Toyota 10P15C, Nippondenso 10PA17,
10PA20, Suction/Discharge Manifold Gasket



Part # 4252
Nippondenso 10P13C/10P15C
Manifold Gasket

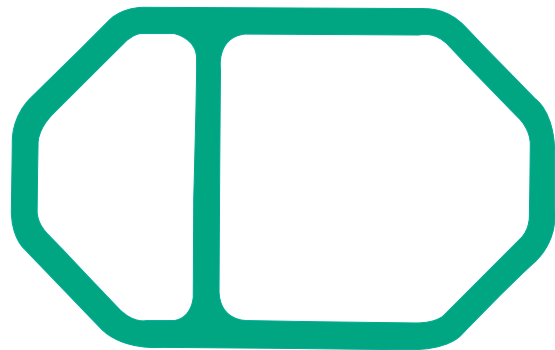

Part # 4253
Gasket - Nippondenso 10PA15, Mercedes

Orings



Orings & Gaskets

All Orings & Gaskets are actual size

Part # 4254

Gasket - Nippondenso 10PA17

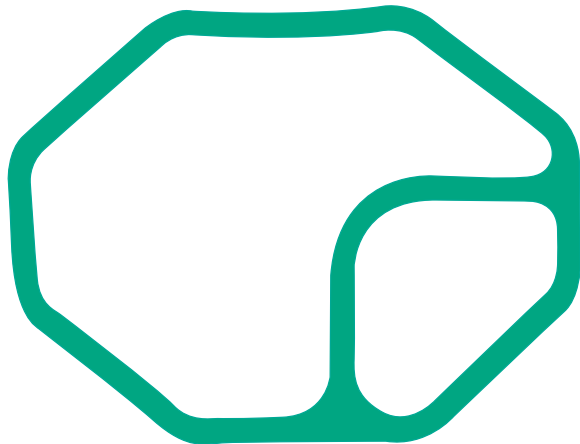

All Orings & Gaskets are High Temperature Green HNBR

Part # 4255

Gasket - Matsushita NL1300 series, Panasonic

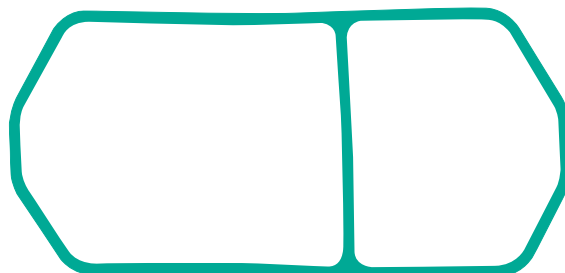

Part # 4256

Gasket - Matsushita NL1301 series, Panasonic

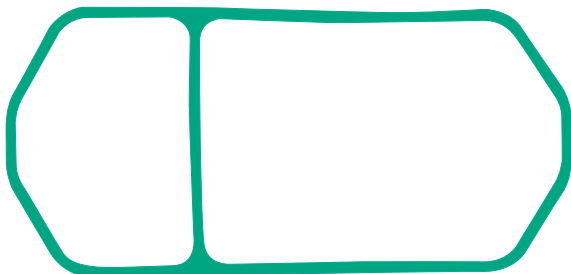

Part # 4258

Gasket - Matsushita, Panasonic SA series

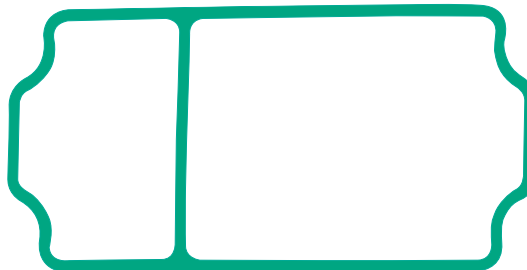

Deluxe Oring Assortment

Part # 4275

- 34 Most Popular Sizes
- 350 Pieces
- Green HNBR



Oring Wall Chart Included

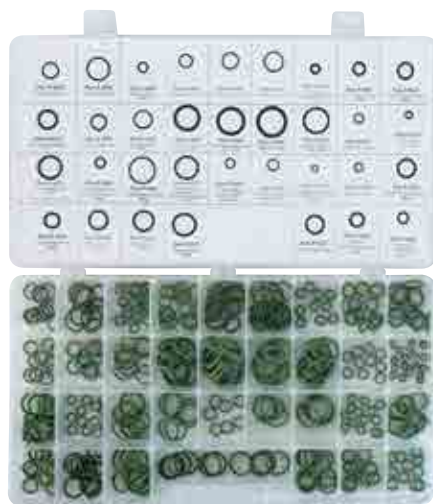

Refer to Page 49 for details

FJC Spray Oring Lubricant

Part # 2206

4 oz. can

- Easy Aerosol spray prepares Oring for installation



Sealing Washers



Chrysler Sealing Washers & Kits

Part # 4053

Chrysler Sealing Washer - Sanden Discharge Port





Part # 4054

Chrysler Sealing Washer - Sanden Suction Port



Part # 4072 Inside Diameter 8.1 mm 	Part # 4361 Inside Diameter 9.5 mm 	Part # 4362 Inside Diameter 15 mm 
Part # 4075 Inside Diameter 17.2 mm 	Part # 4364 Inside Diameter 17.5 mm 	Part # 4365 Inside Diameter 18.0 mm 
Part # 4384 Includes Oring #4187 Chrysler Compressor Discharge Sealing Washer & Oring 	Part # 4385 Includes Oring #4215 Chrysler Compressor Suction Sealing Washer & Oring 	

Ford Sealing Washer Kits

Part # 4388 Includes Oring #4210 Ford Compressor Discharge Sealing Washer & Oring. 	Part # 4389 Includes Oring #4211 Ford Compressor Suction Sealing Washer & Oring. 
---	---

Navistar Sealing Washer Kits

Part # 4381 Includes Oring #4230 Navistar - Truck Suction Sealing Washer & Oring. 	Part # 4382 Includes Oring #4180 Navistar Truck Discharge Sealing Washer & Oring 	Navistar Truck Suction & Discharge Sealing Washer & Oring Pack Part # 4383 Suction & Discharge Gasket & Oring 
---	--	---

Freightliner Sealing Washers

Part # 4370 Freightliner #6 Sealing Washer-Slimline 	Part # 4371 Freightliner #8 Sealing Washer-Slimline 	Part # 4372 Freightliner #10 Sealing Washer-Slimline 	Part # 4376 Freightliner #12 Stat Seal 
--	--	--	---

Heavy Duty Truck Stat Seals Kit

Part # 4459

• Single job kit

Kit Contains:

- 2 Part # 4373
- 2 Part # 4374
- 2 Part # 4375
- 2 Part # 4376
- 2 Part # 4377



Sealing Washers



Sealing Washers

GM Sealing Washers

"All Sealing Washers shown not Actual Size"

 <p>Part # 4060 Color Black Thickness 3.0 mm Outside Diameter 27.9 mm Inside Diameter 15.5 mm</p>	 <p>Part # 4061 Color Silver Thickness 1.3 mm Outside Diameter 31.5 mm Inside Diameter 17.5 mm</p>	 <p>Part # 4062 Color Silver Thickness 1.2 mm Outside Diameter 27.9 mm Inside Diameter 15.5 mm</p>	 <p>Part # 4063 Color Green Thickness 5.5 mm Outside Diameter 29.9 mm Inside Diameter 15.5 mm</p>
 <p>Part # 4064 Color Red Thickness 3.8 mm Outside Diameter 29.9 mm Inside Diameter 15.5 mm</p>	 <p>Part # 4065 Color Yellow Thickness 3.0 mm Outside Diameter 33.2 mm Inside Diameter 15.5 mm</p>	 <p>Part # 4066 Color Silver Thickness 1.2 mm Outside Diameter 23.6 mm Inside Diameter 15.5 mm</p>	<p>Part # 4070 GM Sealing Washer Insert GM Long Manifold Pilot Washer Insert</p>  <p>Part # 4071 Sealing Washer Insert GM V5 Short Manifold Pilot Washer Insert ('88-'91)</p> 

GM Block Fitting Sealing Washers - Slim Line

 <p>Part # 4072 Thickness 1.3 mm Outside Diameter 16.1 mm Inside Diameter 8.1 mm</p>	 <p>Part # 4073 Thickness 1.3 mm Outside Diameter 19.0 mm Inside Diameter 11.1 mm</p>	 <p>Part # 4074 Thickness 1.3 mm Outside Diameter 23.6 mm Inside Diameter 15.5 mm</p>	 <p>Part # 4075 Thickness 1.3 mm Outside Diameter 25.1 mm Inside Diameter 17.2 mm</p>
---	--	---	--

GM Sealing Washers Compressor Service Kits



Part #	Description
4350	Sealing Washer Service Kit for GM 1979-1991. Contains 2 each part # 4060
4351	Sealing Washer Service Kit for GM 1989-1991. Contains 2 each part # 4060 and 4071
4352	Sealing Washer Service Kit for GM 1989-2009. Contains 2 each of part # 4062
4353	Sealing Washer Service Kit for GM A6, LTR4, V5. Contains 1 each of part # 4061 and 4062.
4354	Sealing Washer Service Kit for GM A6, R4. Contains 1 each of part # 4063, 4064, 4065, 4070, 4071.
4355	MasterSealing Washer Service Kit for GM Compressors. Contains 1 each of Part # 4060, 4061, 4062, 4063, 4064, 4065, 4066, 4070, 4071

Master Sealing Washer Assortment

Part # 4296

- 15 Part Numbers - 47 Pieces.
- GM and Chrysler Sealing Washers.

Kit Contains:

3 Part # 4053	3 Part # 4061	2 Part # 4064	4 Part # 4070	4 Part # 4073
3 Part # 4054	3 Part # 4062	2 Part # 4065	4 Part # 4071	4 Part # 4074
3 Part # 4060	2 Part # 4063	2 Part # 4066	4 Part # 4072	4 Part # 4075



Oring Wall Chart Included

























Service Items







Chrysler Metal Gaskets

Gaskets shown are not actual size.

<p>Part # 4123 Includes Oring # 4210 & # 4211</p>  <p>Dodge Truck Compressor Gasket</p>	<p>Part # 4124 Includes Oring # 4211</p>  <p>Dodge Truck Compressor Gasket</p>	<p>Part # 4125 Includes Oring # 4210</p>  <p>Dodge Truck Compressor Gasket</p>	<p>Part # 4126 Includes Oring # 4080</p>  <p>Chrysler 3/8" Drier/ Liquid Line Metal Gasket</p>	<p>Part # 4127 Includes Oring # 4213</p>  <p>Chrysler 5/8" Hose Fitting Metal Gasket</p>
<p>Part # 4128 Dodge Truck Compressor Gasket Use with FJC #4210 Oring</p> 	<p>Part # 4129 Dodge Truck Compressor Gasket Use with FJC #4211 Oring</p> 	<p>Part # 4132 Chrysler 3/8" Drier/ Liquid Line Metal Gasket Use with FJC #4080 Oring</p> 	<p>Part # 4133 Chrysler 5/8" Hose Fitting Metal Gasket Use with FJC #4213 Oring</p> 	
<p>Part # 4162 Metal Gasket Chrysler Bottle Block (.377" 9.6mm Pilot Bolt Hole)</p> 	<p>Part # 4158 Metal Gasket Chrysler Receiver Drier (.437" 11.1mm Pilot Bolt Hole)</p> 	<p>Part # 4160 Metal Gasket Chrysler Suction Line Flange</p> 	<p>Part # 4130 Metal Gasket Chrysler RV2 Suction Port</p> 	
<p>Part # 4142 Metal Gasket Chrysler 6C17 Discharge Port</p> 	<p>Part # 4143 Metal Gasket Chrysler 6C17 Suction Port</p> 	<p>Part # 4131 Metal Gasket Chrysler RV2 Discharge Port</p> 	<p>Part # 4150 Metal Gasket Chrysler Manifold to Expansion Valve</p> 	<p>Part # 4151 Metal Gasket Chrysler Condenser Manifold</p> 
<p>Part # 4154 Metal Gasket Chrysler TXV to Evaporator (gold valve)</p> 	<p>Part # 4166 Metal Gasket Chrysler TXV to Evaporator (gold to black valve)</p> 	<p>Part # 4140 Metal Gasket Chrysler A590/C171 Suction/Discharge Port</p> 	<p>Part # 4144 Metal Gasket Chrysler Suction Line</p> 	





Gaskets

 <p>Part # 4015 York/Tecumseh Gasket</p>	 <p>Part # 4016 York/Tecumseh Lathe Cut Flange Seal</p>	 <p>Part # 4017 York/Tecumseh Lathe Cut Seal</p>	 <p>Part # 4018 York/Tecumseh Teflon Rotolock Seal</p>
--	---	---	--











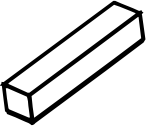
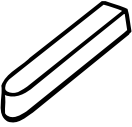



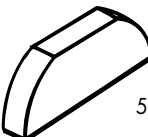
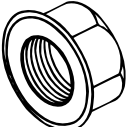



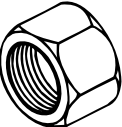

Service Items

Garter Springs For Spring Lock Couplers

			
Part # 4116 #6 Ford Coupling Garter Spring	Part # 4118 #8 Ford Coupling Garter Spring	Part # 4120 #10 Ford Coupling Garter Spring	Part # 4122 #12 Ford Coupling Garter Spring

Service Parts Parts shown are not actual size

 Part # 4319 Shaft Key GM A6/R4	 Part # 4317 Shaft Key Long A590/C171/ FS6/Nippondenso	 Part # 4318 Shaft Key Short 6C17/10P's	 Part # 4324 Shaft Key York/Tecumseh
 Part # 4315 Shaft Key Keihin 150L/15R Chrysler RV2	 Part # 4320 Shaft Key SD 505(mini)/708/709	 Part # 4321 Shaft Key Sanden 507/508/510 (large)	 Part # 4328 GM A6/R4 Flanged Hub Locknut
 Part # 4325 Ford .395 FX15 Mounting Bushing	 Part # 4307 Clutch Shim .005 Keihin 150L/150R	 Part # 4305 Clutch Shim .008 10PA/10PO8E/A590/ C171/DKS16H/FS6/HR980	 Part # 4327 A590/C171/FS6/ 6P127A,B/ 6P34/10PO8E/ HR980 Clutch Nut
 Part # 4326 Ford .595 FX15 Mounting Bushing	 Part # 4308 Clutch Shim .015 Nippondenso 10P17/10PA/FX15/ SS170PSS/ TY12/TY14C	 Part # 4306 Clutch Shim .020 A590/C171/DKS16H/ FS6/10PA/10PO8E	 Part # 4034 #8 Dual Fitting Gasket
 Part # 4346 6C17/FX15/ GM Retaining Ring	 Part # 4345 GM Clutch Hub Retaining Ring	 Part # 4335 C171 Clutch Washer	 Part # 4035 #10 Dual Fitting Gasket
			 Part # 4036 #12 Dual Fitting Gasket

Assortments

Keyway & Nut Assortment

Part # 4302



Kit Contains:

- 5 Part # 4315
- 5 Part # 4317
- 5 Part # 4318
- 5 Part # 4319
- 5 Part # 4320
- 5 Part # 4321
- 5 Part # 4324
- 3 Part # 4327
- 2 Part # 4328
- 5 Part # 4335
- 5 Part # 4345
- 5 Part # 4346

Shim Assortment

Part # 4303

Kit Contains:

- 5 Part # 4305
- 5 Part # 4306
- 5 Part # 4307
- 5 Part # 4308
- 5 Part # 4312
- 2 Part # 4325
- 2 Part # 4326



Retrofit Kits / Assortments



Basic Retrofit Kit

Ester Oil Kit

Part # 2538

Kit Contains:

- 8 ounces of Estercool™ Oil.
- Retrofit Decal.
- High & Low Side R134a Service Port Adapters 2602, 2603, 2604.
- High & Low Side R134a Service Port Caps.



PAG Oil Kit

Part # 2538P

Kit Contains:

- 8 ounces of FJC Universal PAG Oil.
- Retrofit Decal.
- High & Low Side R134a Service Port Adapters 2602, 2603, 2604.
- High & Low Side R134a Service Port Caps.



Part #	Application
2538 2538P	These Retrofit Kits will fit virtually all cars, light trucks, vans, heavy duty trucks, agricultural, and off road equipment using a mobile air conditioning type system. Depending on the type and condition of the system, retrofitting may require additional parts not contained in this kit.

FJC Master Retrofit Kit

Part # 2518

- Contains the parts and instructions necessary to retrofit virtually any R12 system to R134a.
- Was created through an advanced research and development program.
- The retrofitted system using R134a should perform as well as the R12 system.

Kit Contains:

- 1 Part # 2032 - FJC A/C Flush Solvent
- 1 Part # 2408 - 8 oz. Estercool™ Oil
- 1 Part # 2602 - R134a Service Port Low Side
- 1 Part # 2603 - R134a Service Port High Side
- 1 Part # 2604 - R134a Service Port High Side
- 1 Part # 2614 - R134a Service Port Cap
- 1 Part # 2615 - R134a Service Port Cap
- 1 Part # 2687 - Retrofit Decal
- 1 Part # 2815 - Step-By-Step Instruction Manual: "A Guide To Retrofitting"



Retrofit Kits



Part #	Application
2530	These Retrofit Kits will fit virtually all cars, light trucks, vans, heavy duty trucks, agricultural, and off road equipment using a mobile air conditioning type system. Contains adapters: Part # 2602, 2603, 2604

Includes:

- 8 ounces of Estercool™ Oil.
- Step-By-Step Instruction Manual: "A Guide to Retrofitting".
- Retrofit Decal.
- High & Low Side R134a Service Port Adapters.
- High & Low Side R134a Service Port Caps.

R134a Retrofit Assortment

Part # 2665

- Contains the adapters necessary to retrofit virtually any mobile A/C system.
- Plastic 18 compartment tray with easy to read locator chart.
- Adapters meet SAE J639 specifications.

Kit Contains:

- 10 Part # 2602
- 5 Part # 2603
- 5 Part # 2604
- 3 Part # 2606
- 10 Part # 2614
- 10 Part # 2615
- 5 Part # 2617
- 3 Part # 2618
- 3 Part # 2620
- 1 Part # 2632
- 1 Part # 2633
- 1 Part # 2634
- 5 Part # 2672
- 3 Part # 2673
- 10 Part # 2687



R134a Retrofit Assortment

Part # 2662

- Contains adapters necessary to Retrofit mobile A/C systems.
- Adapters meet SAE J639 specifications.

Kit Contains:

- 6 Part # 2602
- 4 Part # 2603
- 2 Part # 2604
- 1 Part # 2606
- 6 Part # 2614
- 6 Part # 2615
- 1 Part # 2618
- 1 Part # 2620
- 5 Part # 2672
- 6 Part # 2687





Retrofit Products

R134a Service Port Adapters

Remove R12 valve core from vehicle Before installing #2602 containing valve core.

Straight Low Side
1/4" Flare (7/16" SAE)



Part # 2602
Use cap #2614

Straight High Side
3/16" Flare (3/8" SAE)



Part # 2603
Use cap #2615

Straight High Side
1/4" Flare (7/16" SAE)



Part # 2604
Use cap #2615

Straight High Side
2 Piece GM



Part # 2606
Use cap #2615

90° Low Side
1/4" Flare (7/16" SAE)



Part # 2632
Use cap #2614

90° High Side
3/16" Flare (3/8" SAE)



Part # 2633
Use cap #2615

90° High Side
1/4" Flare (7/16" SAE)



Part # 2634
Use cap #2615

- R134a service port adapters will adapt existing R12 service ports to R134a service ports.
 - Will accept standard R134a Quick Couplers used with R134a manifold gauge sets.
 - Use when retrofitting from R12 to R134a.
 - R134a service port adapters meet SAE J639 standards.
- Note:** When using part #'s 2632, 2633 or 2634, remove original valve core prior to installing.

R12 & R134a Service Port Caps

Blue Low Side



15mm Fitting
8mm Threads
Part # 2614

Red High Side



17mm Fitting
8mm Threads
Part # 2615

R12 Service Port Termination Caps

1/4" Flare (7/16" SAE)
Part # 2618



3/16" Flare (3/8" SAE)
Part # 2620

High Pressure Shutoff Switch Assembly

Part # 3245



- Contacts open at 410 psi and close at 150 psi.
- Install on systems without a high pressure shut off switch to prevent damage from high head pressure and to comply with EPA regulations.
- Use Tee Adapter with 10mm switch port.
- Includes switch and connector w/ leads.
- Includes wiring instructions.
- Refer to "A Guide To Retrofitting" for the EPA Regulation.

Cycling Pressure Switches Retrofit

R134a Compressor Clutch Cycling Pressure Switches

Part # 3225 (GM 1978 - 1993)

Part # 3227 (GM - CK Truck 1989 - 1993)

Part # 3238 (Ford 1981 - 1993)

- For use on systems which have been retrofitted from R12 to R134a.
- Replaces R12 cycling pressure switches.
- When retrofitting, these switches have a lower cycle off pressure to compensate for the difference between R12 and R134a.
- Use these switches as instructed by the "Guide to Retrofitting" Manual.



Part # 3225



Part # 3227



Part # 3238



Detail of
Part # 3227

Retrofit Decal

Part # 2687

10 per pack

Install decal to inform anyone servicing the air conditioning system in the future that it has been retrofitted to R134a.



Retrofit Manual

"A Guide To Retrofitting"

Fourth Edition

Part # 2815

- Covers most vehicles from 1970 to present.
- R134a refrigerant capacities chart for retrofitting systems.
- Troubleshooting chart.
- Refrigerant oil capacities chart.



 **FJC** continues to expand with..

 **FJC**

Power Division





Battery Testers

12 V Battery Tester

Part # 45125

- 3.9V - 19.9V.
- 90CCA - 1400CCA.
- Tests 12V starting/charging systems.
- Battery condition shown in percentage of capacity.
- Uses conductance technology.
- Detects bad cells - reverse polarity protection.
- Made in USA
- Case Included



12/24/36 V Battery Tester

Part # 45135

- 3.9V - 49.9V.
- 390CCA - 1700CCA.
- Tests 12/24/36 V starting/charging systems.
- Tests 42 V mild hybrid systems
- 4 ft. cable.
- Uses conductance technology.
- Tests flooded lead acid & AGM batteries.
- Made in USA
- Case Included



6/12/24/36 V Battery Tester

Part # 45150

- 0V - 49.9V.
- 100CCA - 3500CCA.
- Tests 6/12/24/36 V starting/charging systems.
- Tests 42 V mild hybrid systems.
- Tests series & parallel batteries.
- Displays alternator output voltage.
- Alternator ripple test & starter system draw.
- Made in USA
- Case Included.



Carbon Pile Battery Tester - 1000 AMP

Part # 45118

- 1000 AMP
- Load tests 6V/12V/24V batteries
- Test alternators, regulators & starters
- Test Batteries up to 2000 cold cranking amps
- Separate Volt and Amp meters
- 56 in solid copper cables with HD clamps



Carbon Pile Battery Tester - 500 AMP

Part # 45115

- 500 AMP
- Load tests 12V batteries
- Test alternators, regulators & starters
- Tests batteries up to 160Ah/1000 cold cranking amps
- Separate volt and amp meters
- Solid copper cables with heavy duty clamps



Battery Testers & Maintainers



125 AMP Battery Tester

Part # 45107

- Tests 6 & 12 Volt Batteries
- Test car/truck batteries of current draw, voltage, and alternator performance
- Quick 10 second load test



100 AMP Battery Tester

Part # 45110



Battery Chargers/Maintainers



500mA
Part # 52005



1 AMP
Part # 52010



1.5 AMP
Part # 52015

2 AMP
Part # 52020

- 12V charger that keeps batteries charged and maintaining them to peak performance
- Maintains charge in installed batteries without having to disconnect battery from vehicles, boats, motorcycles, snowmobiles, etc.
- Automatically switches between charging mode and float mode monitoring

Battery Cleaner & Protectant Spray

**FJC Battery
Cleaner - 14 oz**
Part # 45915



- Cleans dirt and grease
- Neutralizes battery acid corrosion
- Extends battery life

**FJC Battery
Protector - 12 oz**
Part # 45918



- Prevents corrosion on battery terminals and cable connections
- Seals out moisture - will not wash off



Power Inverters



Part # 53040



Part # 53070



Part # 53100



Part # 53150

Part #	Watts
53040	Inverter - 400 watt
53070	Inverter - 700 watt
53100	Inverter - 1000 watt
53150	Inverter - 1500 watt
53200	Inverter - 2000 watt
53300	Inverter - 3000 watt
53500	Inverter - 5000 watt



Part # 53200

- Converts 12V DC Power into 120V AC Power with Multiple Outlets
- Provides Portable AC Power for Cars, Trucks, RV, and Boats - Use with Portable Handheld Tools, TV's, Electric Lights, Computers and more
- Connection Cables and Instructions Included
- Low Battery Alarm - Overload Protection - Short Circuit Protection



Part # 53300



Part # 53500

CAUTION: Read enclosed manuals carefully before operation. Failure to install properly could result in battery failure or electrocution.

Professional Booster Cables

Part #	Duty Rating	Wire Gauge	Clamp AMP Rating	Length in Ft.	Clamp	Package
45215	Light	10	250	12	STD	Sleeve
45223	Standard	8	500	12	STD	Box
45229	Heavy	6	600	16	STD	Box
45233	Extra Heavy	4	600	16	Parrot	Box
45234	Extra Heavy	4	600	20	Parrot	Box
45244	Commercial	2	600	20	Parrot	Box
45245	Commercial	2	600	25	Parrot	Box
45255	Commercial	1	800	25	HD	Plastic Case
45265	Commercial	2/0	800	25	HD	Plastic Case

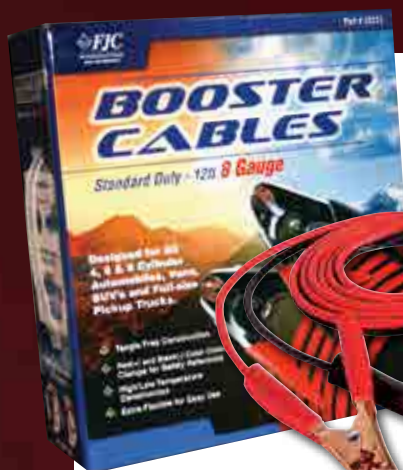

Light Duty Cable



Standard Duty Cable



Heavy Duty Cable



Commercial Duty Cable



Heavy Duty 600 AMP Replacement Clamp Sets



Part # 45262

Commercial Duty 800 AMP Replacement Clamp Sets



Part # 45268



Booster Cable Displays

FJC Booster Cable Display - 3 Ft

Part # 53973



- 8 Part Numbers
- 21 Items
- Pegboard Hooks and Planogram Included

- 4 Ea. Part # 45215
- 2 Ea. Part # 45223
- 2 Ea. Part # 45229
- 4 Ea. Part # 45233
- 3 Ea. Part # 45234
- 2 Ea. Part # 45244
- 2 Ea. Part # 45245
- 2 Ea. Part # 45255

* Endcap fixture is NOT included



FJC Deluxe Cable Display - 4 Ft

Part # 53974



- 15 Part Numbers
- 44 Items
- Pegboard Hooks and Planogram Included

- 2 Ea. Part # 45215
- 3 Ea. Part # 45223
- 3 Ea. Part # 45229
- 3 Ea. Part # 45233
- 3 Ea. Part # 45234
- 3 Ea. Part # 45244
- 3 Ea. Part # 45245
- 2 Ea. Part # 45255
- 2 Ea. Part # 45262
- 2 Ea. Part # 45268
- 2 Ea. Part # 46139
- 2 Ea. Part # 46330
- 6 Ea. Part # 45915
- 6 Ea. Part # 45918
- 2 Ea. Part # 46141

* Gondola fixture NOT included

Booster Cable Displays

Power Division Displays



FJC Power Division Display - 3 Ft

Part # 53983



- 29 Part Numbers
- Pegboard Hooks and Planogram Included

- | | |
|--------------------|--------------------|
| 1 Ea. Part # 45107 | 1 Ea. Part # 46226 |
| 1 Ea. Part # 45110 | 1 Ea. Part # 46230 |
| 1 Ea. Part # 46136 | 1 Ea. Part # 46321 |
| 1 Ea. Part # 46139 | 1 Ea. Part # 46325 |
| 1 Ea. Part # 46141 | 1 Ea. Part # 46326 |
| 1 Ea. Part # 46155 | 1 Ea. Part # 46330 |
| 1 Ea. Part # 46156 | 1 Ea. Part # 46335 |
| 1 Ea. Part # 46162 | 1 Ea. Part # 52005 |
| 1 Ea. Part # 46164 | 1 Ea. Part # 52010 |
| 1 Ea. Part # 46174 | 1 Ea. Part # 52015 |
| 1 Ea. Part # 46215 | 1 Ea. Part # 52020 |
| 1 Ea. Part # 46217 | 1 Ea. Part # 53040 |
| 1 Ea. Part # 46219 | 1 Ea. Part # 53070 |
| 1 Ea. Part # 46222 | 1 Ea. Part # 53150 |
| 1 Ea. Part # 46224 | |

* Endcap fixture NOT included



FJC Power Division Display - 4 Ft

Part # 53984



- 34 Part Numbers
- Pegboard Hooks and Planogram Included

- | | |
|--------------------|--------------------|
| 1 Ea. Part # 43648 | 1 Ea. Part # 46230 |
| 1 Ea. Part # 45107 | 1 Ea. Part # 46321 |
| 1 Ea. Part # 45110 | 1 Ea. Part # 46325 |
| 1 Ea. Part # 45115 | 1 Ea. Part # 46326 |
| 1 Ea. Part # 46136 | 1 Ea. Part # 46330 |
| 1 Ea. Part # 46139 | 1 Ea. Part # 46335 |
| 1 Ea. Part # 46141 | 1 Ea. Part # 52005 |
| 1 Ea. Part # 46155 | 1 Ea. Part # 52010 |
| 1 Ea. Part # 46156 | 1 Ea. Part # 52015 |
| 1 Ea. Part # 46162 | 1 Ea. Part # 52020 |
| 1 Ea. Part # 46164 | 1 Ea. Part # 53040 |
| 1 Ea. Part # 46173 | 1 Ea. Part # 53070 |
| 1 Ea. Part # 46174 | 1 Ea. Part # 53100 |
| 1 Ea. Part # 46217 | 1 Ea. Part # 53150 |
| 1 Ea. Part # 46219 | 1 Ea. Part # 53200 |
| 1 Ea. Part # 46222 | |
| 1 Ea. Part # 46224 | |
| 1 Ea. Part # 46226 | |

* Gondola fixture NOT included

Power Division Displays



Battery Tools & Accesories



4 in 1 Battery Cleaner

Part # 46136

- Service Most Battery Types
- Reshape Post/Terminals



Battery Terminal Cleaner

Part # 46139

- Cleans Terminal Posts and Cable Ends



Battery Terminal Cleaner w/Brush

Part # 46141

- Sturdy Plastic Housing with Steel Brushes
- Cleans Terminals

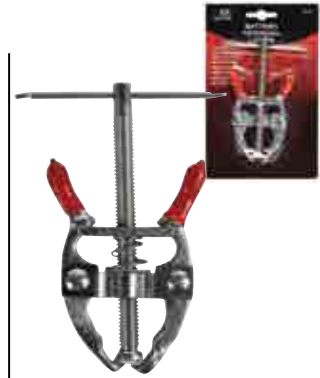

Top Post Battery Terminal Lifter

Part # 46155

- Remove terminal easily from top post battery



Deluxe Top Post Battery Terminal Lifter

Part # 46156

- Heavy Construction with a Spring Load Assist



Battery Terminal Pliers

Part # 46162

- Rubber Coated Handle for Comfort and Tight Grip



Battery Terminal Spreader

Part # 46164

- Spreads Battery Terminals
- Coated Handle



HD Adjustable Battery Carrier

Part # 46173

- Adjusts to Batteries Up to 7 1/2" Wide
- Riveted Pads



14" Battery Strap

Part # 46174

- Convenient Way to Carry Top Post Batteries



5/16" Extended Terminal Ratchet

Part # 46325

- Long Reach - Coated Handle



5/16" Terminal Ratchet

Part # 46321

- Coated Handle - fits 5/16" Bolts



10mm Terminal Ratchet

Part # 46326

- Coated Handle - fits 10mm Bolts

Battery Tools & Accesories



7 Piece Battery Maintenance Kit

Part # 46330



Kit Includes	
Part # 46136	4 in 1 Battery Cleaner
Part # 46155	Top Post Battery Lifter
Part # 46162	Battery Terminal Pliers
Part # 46164	Battery Terminal Spreader
Part # 46325	5/16" Extended Terminal Ratchet
Part # 46321	5/16" Terminal Ratchet
Part # 46326	10 mm Terminal Ratchet



46162



46325

Battery Hold-Down with J-Style Bolts

Part #	Description
46222	5" Hold-Down w/ 8" J-Style Bolt
46224	7" Hold-Down w/ 10" J-Style Bolt
46226	7" Hold-Down w/ 12" J-Style Bolt



J-Style Battery Hold - Down Bolts

Part #	Description
46215	J-Style Hold-Down Bolt 8"
46217	J-Style Hold-Down Bolt 10"
46219	J-Style Hold-Down Bolt 12"



Universal Battery Hold-Down Bracket



Part #	Description
46230	Universal Battery Hold-Down Bracket



Battery Hydrometer

Part # 46335

- Indicator Dial Shows Battery Charge & Specific Gravity

Antifreeze/Coolant Hydrometer

Part # 43648

- Indicator Dial with F° and C° Scale



2 Qt. Battery Filler

Part # 46342

- Auto Shutoff Valve Prevents Overflowing
- Acid Resistant

Radiator Test Tools

Heavy Duty Cooling System Pressure Test & Refill Kit

Part #43655



- FJC Heavy Duty Cooling System Test and Refill Kit uses shop air to maintain constant pressure to the cooling system during testing and refill. Our kit helps eliminate the complications often experienced with unreliable rubber plugs or bladders, saving setup time and providing more accurate test results. Quick-disconnect vacuum attachment allows rapid refilling of the cooling system, and eliminates airlocks
- Our kit is designed for use with Freightliner, International, Kenworth, Peterbilt, Mack, Volvo, GMC and Sterling cooling systems
- Our kit includes heavy duty vehicle adapters, a pressure test regulator, a vacuum refill attachment with tubing, all in a durable storage case
- Our FJC Heavy Duty Cooling System Test and Refill Kit, PART # 43655 is proudly made in USA

Radiator Test Tools



FJC Master Radiator & Radiator Cap Pressure Test Kit

Part # 43645

- For Use in Testing Radiators and Radiator Caps
- Confirms Radiator and Cooling Systems Leaks
- Test Radiator Caps for Proper Operation
- Includes Adapters for Late Model GM & Ford

Use to test the following vehicles			
Chrysler	Nissan	Lexus	Mercedes Benz
Ford	Mazda	Honda	Jeep
GM	Toyota	Audi	SAAB
Mitsubishi	Infiniti	BMW	Volvo
VW			

Location in Case	Part #	Location in Case	Part #	Part #	Description	Size	Color
0	43700	13	43813	43700	Thermometer	-	-
1	43801	14	43814	43801	Hand Pump	-	-
2A	43802BK	15	43815	43802BK	Tester Adaptor	Black	Blue
2B	43802BL	16	43816	43802BL	Tester Adaptor	Blue	Blue
3	43703	17	43617	43703	Tester Adaptor	2 1/4"	Blue
5	43704	18	43618	43704	Tester Adaptor	1 3/4"	Blue
4	43705	19	43619	43705	Tester Adaptor	1 5/8"	Blue
6	43806	20	43620	43806	Tester Adaptor	Gold	Gold
7	43807	21	43816	43807	Tester Adaptor	Brown	Brown
8	43808			43808	Tester Adaptor	White	White
9	43809			43619	Tester Adaptor	Purple	Purple
10	43810			43810	Tester Adaptor	Gray	Gray
11	43811			43811	Tester Adaptor	Red	Red
12	43812			43812	Tester Adaptor	Green	Green
				43813	Tester Adaptor	Blue	Blue
				43814	Tester Adaptor	Yellow	Yellow
				43815	Tester Adaptor	Pink	Pink
				43616	Tester Adaptor	Violet	Violet
				43617	Tester Adaptor	Lt Blue	Lt Blue
				43618	Tester Adaptor	Sea Green	Sea Green
				43619	Tester Adaptor	Purple	Purple
				43620	Tester Adaptor	White	White
				43621	Tester Adaptor	Tan	Tan
				43816	Cap Wrench	-	-
				43624	Replacement Gasket Kit	-	-

FJC Radiator Pressure Test Kit

Part # 43650



Slot #	Part #
0	43700
1	43701
2	43702
3	43703
4	43704
5	43705
6	43706
7	43707
8	43708
9	43709
10	43710
11	43711
12	43712
13	43713

- Use Pressure Pump with Adapters to Test Radiator & Cooling Systems.
- Blow Molded Case Keeps Tools Organized and Easy to Carry.

Part # 43650 Replacement Parts

Part #	Description	Size/Color	Part #	Description	Size/Color
43700	Thermometer	-	43708	Tester Adapter	Blue
43701	Hand Pump	-	43709	Tester Adapter	Copper
43702	Tester Adapter	2 3/4"	43710	Tester Adapter	Gold
43703	Tester Adapter	2 1/4"	43711	Tester Adapter	Green
43704	Tester Adapter	1 3/4"	43712	Tester Adapter	Purple
43705	Tester Adapter	1 5/8"	43713	Tester Adapter	Red
43706	Tester Adapter	Brown	43715	Replacement Gasket Kit	-
43707	Tester Adapter	Aqua			

Use to test the following vehicles

Chrysler	Honda
Ford	Audi
GM	BMW
Mitsubishi	Mercedes
Nissan	Benz
Mazda	Jeep
Toyota	SAAB
Infiniti	Volvo
Lexus	VW

Note: Does not fit all years of all models of vehicles shown above

FJC Radiator and Radiator Cap Pressure Test Kit

Part # 43658

Slot #	Part #	Slot #	Part #
0	43700	8	43808
1	43801	9	43809
2	43802BK	10	43810
2	43803BL	11	43811
3	43703	12	43812
4	43704	13	43813
5	43705	14	43814
6	43806	15	43815
7	43807		



- For Use in Testing Radiators and Radiator Caps.
- Confirms Radiator and Cooling Systems Leaks.
- Test Radiator Caps for Proper Operation.

Part # 43658 Replacement Parts

Part #	Description	Size/Color	Part #	Description	Size/Color
43700	Thermometer	-	43809	Tester Adapter	Purple
43703	Tester Adapter	2 1/4"	43810	Tester Adapter	Gray
43704	Tester Adapter	1 3/4"	43811	Tester Adapter	Red
43705	Tester Adapter	1 5/8"	43812	Tester Adapter	Green
43801	Hand Pump	-	43813	Tester Adapter	Blue
43802BK	Tester Adapter	Black	43814	Tester Adapter	Yellow
43802BL	Tester Adapter	Blue	43815	Tester Adapter	Pink
43806	Tester Adapter	Gold	43816	Cap Wrench	-
43807	Tester Adapter	Brown	43820	Replacement Gasket Kit	-
43808	Tester Adapter	White			



Late Model Ford Radiator Pressure Tester Adapter

Part # 43831

- For Use with FJC Pressure Test Kits Shown Above



Late Model GM Radiator Pressure Tester Adapter

Part # 43826

- For Use with FJC Pressure Test Kits Shown Above



Radiator Test Tools

Radiator Coolant Vacuum Refill Kit

Part # 43610

- Uses Shop Air to Evacuate & Leak Test an Auto's Cooling System
- Use to Refill Coolant in Minutes



Hand-Held Refractometer with Automatic Temperature Compensation

Part # 43910

- Tests the Concentration of the Battery Fluids, Antifreeze Liquid and Cleaning Fluids
- Metal Body with Rubber Grip
- Includes Case



Battery Hydrometer

Part # 46335

- Indicator Dial Shows Battery Charge & Specific Gravity



Antifreeze/Coolant Hydrometer

Part # 43648

- Indicator Dial with F° and C° Scale



Radiator/Radiator Cap Pressure Test and Radiator Vacuum Refill Combo Kit

Part # 43670

"Performs Quick Inspection, Leak Detection and Refill of Most Automotive Radiators"

Radiator and Radiator Cap Pressure Test Kit

- For Use in Testing Radiators and Radiator Caps.
- Confirms Radiator and Cooling Systems Leaks.
- Test Radiator Caps for Proper Operation.
- Refer to Page 10 for Replacement Items.



Radiator Coolant Vacuum Refill Kit

- Uses Shop Air to Evacuate & Leak Test an Auto's Cooling System
- Use to Refill Coolant in Minutes

Part # 43658

Part # 43610

